

# VH Fan-Coil Units Hi-Rise, Vertical



# VH Fan-Coil Units: Raising the Standard in Flexibility and Performance

## Owners

AHRI Standard 440-certification ensures exacting performance. The VH fan-coil unit's 3-speed, direct-drive motor allows optimized cabinet airflow and sound performance. Enhanced sound levels are achieved through an electronic fan-speed controller (SCR) which allows further motor-speed fine tuning. VH fan-coil units are constructed of galvanized steel, surpassing the ASTM 125-hour, salt-spray test for corrosion and rust. Decorator front panels, supply grilles, and exposed-cabinet model VHE feature durable, powder-coat paint that resists fading, scratches and fingerprints.

ENVIRO-PAC™ models VHA/VHB tandem units ship complete with risers enclosed in a wall plenum with one layer of 5/8" gypsum for sound attenuation. ENVIRO-PAC™ units may be ordered with two layers of gypsum and fire-blocking material for a one-hour fire rating per UL 1479.

Concerned about Indoor Air Quality? Sloped drain pans are standard on VH fan coils. The coils are easily removed for cleaning. As an option, field-removable drain pans may be supplied. Optional stainless-steel drain pans and coil casings are available. IAQ lining options include foil-faced or elastomeric, closed-cell-foam insulation.

## Designers

The VH unit's impressive list of standard features provides unparalleled design flexibility. Riser-slot knockouts are included on the left, right and back panels. Supply-air-opening knockouts are included on all sides, as well as the top of the unit. Outside air can be introduced with manual or motorized dampers.

Coil options allow for three or four-row chilled-water and one or two-row hot-water coils in the reheat position. A total of five rows of coil are accommodated.

## Contractors

VH fan-coil units provide maximum performance while reducing installed cost to the contractor. Motor wiring is brought to a control compartment on the inside of the unit, reducing electrical hook-up time. Internal stainless-steel-braided hoses allow easy field-configuration of riser connections without the need for thermal cutting and joining of piping.

Risers may ship in advance of the unit to facilitate installation and fire-safing of floor penetrations in limited space. Additionally, fan-coil units are protected from construction debris during installation and pressure testing of the risers.

VH Fan-Coil Units Airflow (CFM)

Unit Size	Nominal
03	350
04	450
06	600
08	800
10	1000
12	1200

Actual performance may vary based on model, options and operating conditions. Refer to Web-Select® at [enviro-tec.com](http://enviro-tec.com) for complete performance information.



## Factory-Mounted Control Packages

A wide variety of control options and thermostats are offered. Factory-mounting and wiring of DDC controls by others is also available.

## Silent Relays

Silent, solid-state relays are available for fan and electric-heat control in sound-sensitive environments.

## Factory-Furnished Valve Packages

Valve packages provided by the factory ensure proper fit, operation and performance.

## Electric Heat

A variety of kW and voltage configurations are available. Options include door-interlock disconnects, low-voltage controls, and silent solid-state relays. All control and electric-heat configurations include single-point-power connection and are cETL listed as an assembly.



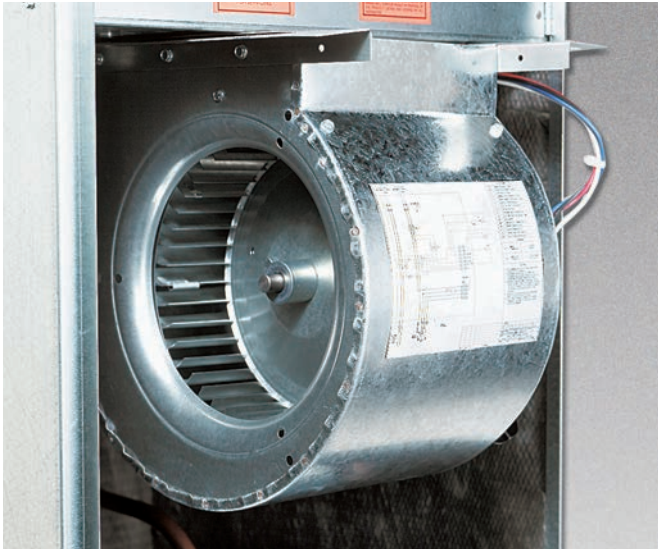

### Fan Deck

For ease of service, the fan/motor assembly is easily removed by unscrewing two locknuts located at the front of the assembly. Slide rails support the fan during removal and installation, and the electrical harness is equipped with a quick-connect plug.

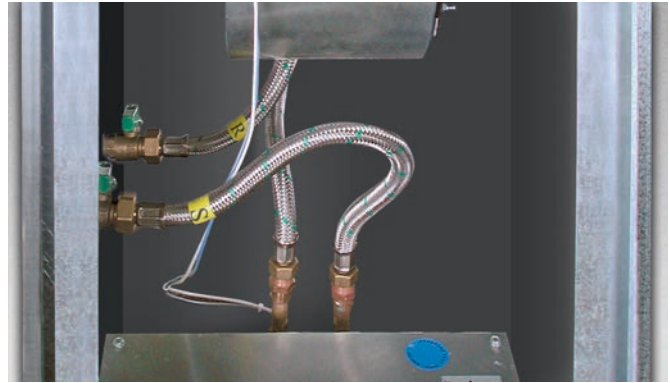

### Coils And Piping

All units are available in 2-pipe or 4-pipe configurations. The heating coil is standard in the reheat position. Access for cleaning on both the entering and leaving-air sides is available. Coils are removable from the front of the unit for service.

### Risers

Risers, coils and piping packages are pressure-tested and ship installed on the unit as a complete package. Risers may also ship in advance of the unit. This option greatly simplifies installation, while keeping the units free of construction debris during pressure-testing of the risers.

### Filters

Filter options include 1" throwaway (standard), pleated MERV 6, or synthetic media. Filters are easily replaceable from the return air when the front panel is removed.

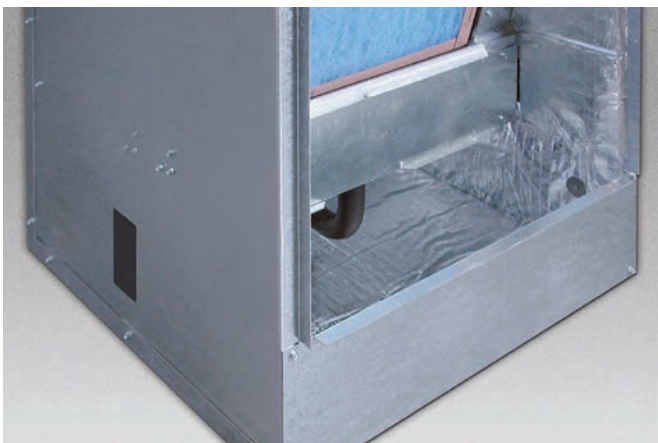

### Drain Pan

The sloped, insulated drain pan is available in stainless-steel construction. Standard drain pans are double wall, composite, extend under the entire coil section, double sloped, and are removable. As an option, the VH drain pan can be equipped for easy removal from the front of the unit for inspection and cleaning. For optimum moisture resistance and cleanability, the unit may be lined with foil-faced fiberglass insulation (shown above) or elastomeric, closed-cell-foam insulation.

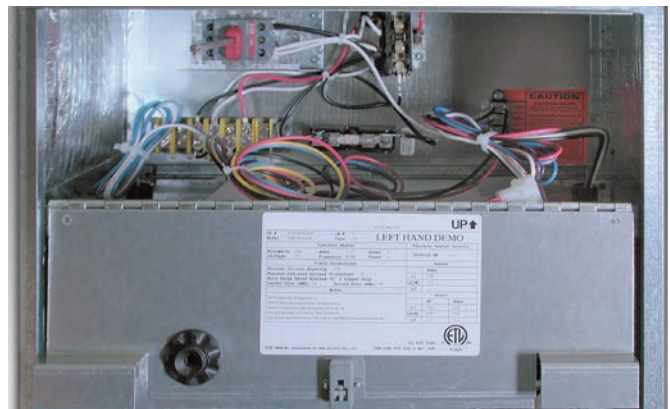

### Control Enclosure

The hinged access door allows entry to a spacious electrical compartment. The compartment houses all electric-heat and control components. Terminal strips are furnished for simple power-wiring and control-wiring connections.

### Powder-Coated Painted Surface

Exposed-cabinet model VHE, as well as the front-return, textured, decorator panel, feature a powder-coat finish that resists scuffing, scratching, fading, and fingerprints.



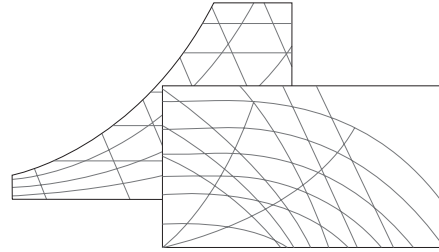
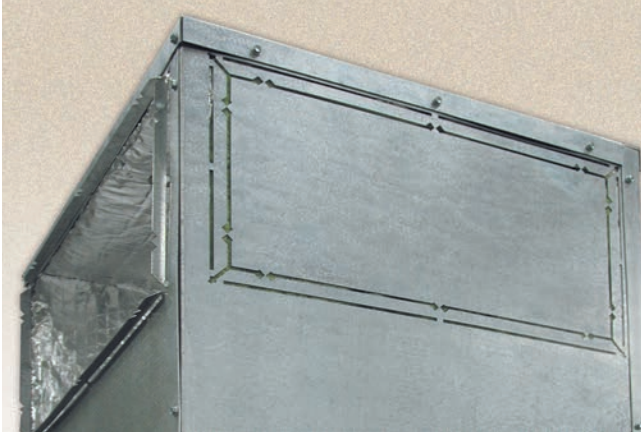

### Online Rating and Selection Program

The Web-Select® tool is the industry's first web-based HVAC rating and selection program. Requiring no installation software or license fees, the Web-Select tool is accessible around the clock to representatives, owners, engineers and contractors. The beauty of this system lies in the sharing of information between users by saving selections into project schedules. Selections can be made and later edited, priced and ordered by your representative. Contact your representative for access to the Web-Select tool.

### Field Configuration

Supply-air-opening knockouts are included on all sides, and the top, of the VH unit. Riser-slot knockouts are included on both sides, as well as the back panels. If requested, the ENVIRO-STAC® ships from the factory with knockouts removed for the selected arrangement of supply air and riser location.



### Stainless-Steel-Braided Hoses

Standard on all 1/2" 2-pipe and 4-pipe systems, stainless-steel-braided hose kits allow for flexibility and thermal expansion within the unit cabinet. The hose-to-coil and hose-to-riser connections are made via a threaded swivel adapter, simplifying coil removal. For more information, see the VH Hose Kit sales sheet at [www.enviro-tec.com](http://www.enviro-tec.com).

Enviro-Tec - Selection Summary

**ENVIRO-TEC®**

Project Name: Test 01-09-15  
 Line #: 29  
 Selection Method: Fixed ESP/Nominal Airflow  
 Selection Date:  
 Coil Version: 7.01d

Ship Cycle: Standard Shipment  
 Tag:  
 Elevation: 0 ft.  
 Printed Date:  
 Notes: This hold is for user purposes only and will not transfer to the order form.

Mfg	Model	Unit Size	Capacity	Airflow (cfm)	OA (inches)	ESP (inches)	Motor (HP)	Motor RPM	Fin Full Load Amps	MCA	MSCP	Fin Wtr/Dry	VPHz	Motor Speed (R)	Weight (lb)	Filter Type	
Enviro-Tec	VHC	03	Standard	347	0	0.05	13.105	800	0.64	0.8	15	86	1	115/180	High	237	1" Thruway

\* Weight does not include accessories.

Fan selection and performance is shown at elevation of 0 ft

Chilled Water Coil											
EAT DBWB (deg F)	LAT DBWB (deg F)	Total Capacity (Btu/h)	Sensible Capacity (Btu/h)	EWTLWT (deg F)	Fluid Flow (gpm)	Fluid PO (ft)	Fluid Velocity (fps)	Air PD (in.wc)	Coil Rows	Coil FPI	No. Circuits
75/163	53.5/152.2	10750	8150	45/55	2.10	13.7	3.2	0.1	3	14	2

Sound Power By Octave Band (dB Re 10 <sup>-12</sup> Watts)							
Band	2	3	4	5	6	7	8
Frequency	125	250	500	1000	2000	4000	8000
Total	59	46	44	38	36	29	27

- Unit data is certified in accordance with AHRI-440
- Sound data tested in accordance with AHRI-350-2000.
  - Total sound power level data based on Vertical H-Rise Concentrated model with fan CFM at corresponding motor tap with 115/180 volt PSC motor, 4 row coil, 1" thruway filter, 0.05" external static pressure and standard rated internal pressure losses.
- Unit pressure drop and CFM based upon dry coil as required by AHRI-440.
- Scheduled motor information is for H-Speed.
- The coil selection has been made on standard conditions.
- Outside Airflow is a user input value for scheduling purposes.

### A completed selection from the Web-Select program

Selections may be shared with other Web-Select users, printed, exported to a spreadsheet or AutoCAD, or saved as a PDF file for emailing.

## VHC Concealed Enviro-Stac® Dimensional Data

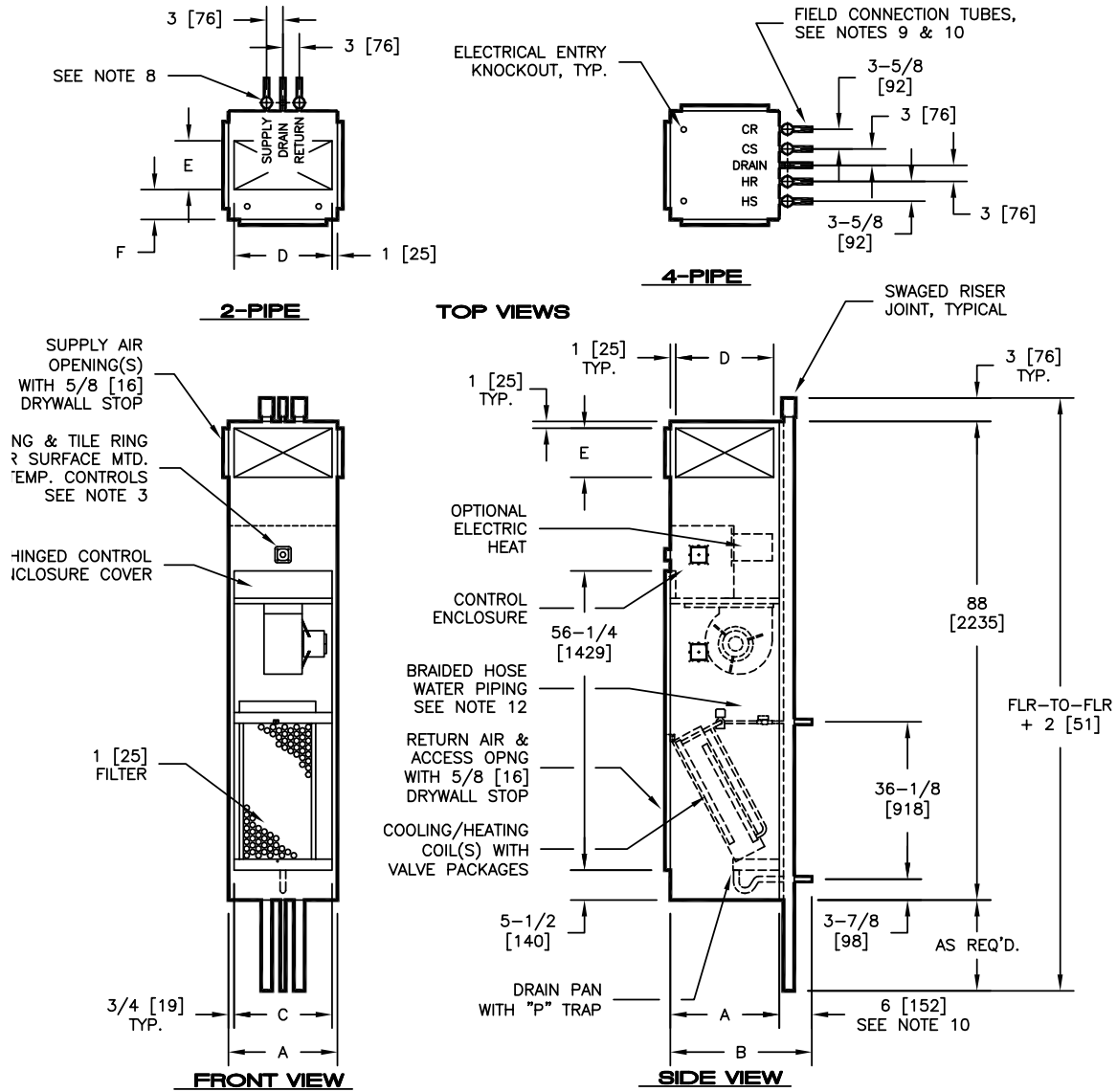

### DIMENSIONS - In [mm]

UNIT SIZE	A	B	C	SINGLE/ DOUBLE SUPPLY		F
				D	E	
03 & 04	18 [457]	24 [610]	16-1/2 [419]	16 [406]	8 [203]	6 [152]
06 & 08	20 [508]	26 [660]	18-1/2 [470]	18 [457]	12 [305]	6 [152]
10 & 12	24 [610]	30 [762]	22-1/2 [572]	22 [559]	14 [356]	8 [203]

**Notes:**

1. All dimensions are inches and are +/- 1/4" [6 mm]. Metric values are soft conversion.
2. Tile ring is installed on front of unit as shown, and may be moved to left or right side of unit in field. Tile ring omitted on units with "ADA" control mounting location.
3. Wiring from electrical entry point to control enclosure is furnished and installed by others in field.
4. Risers available from 3/4" [19mm] to 3" [76 mm] diameter with 1/2" [13 mm] thick insulation, and 3/4" [19mm] to 2-1/2" [64 mm] diameter with 3/4" [19 mm] thick insulation.
5. Riser length is 120" [3078 mm] max, 100" [2540 mm] min.
6. Back riser location shown. See arrangement drawings for available unit configurations.
7. Factory mounted risers shown. Risers may also ship in advance of the unit. See ship-in-advance riser drawings for details.

**Note:** Drawings are not to scale and are not for installation purposes. Refer to [www.enviro-tec.com](http://www.enviro-tec.com) for current submittal drawings. All data and dimensions are subject to change without notice.

# VH Fan-Coil Unit Features

## STANDARD FEATURES:

### Construction

- AHRI Standard 440-certified and labeled
- Galvanized-steel construction
- 1/2" thick fiberglass insulation
- Integral filter rack with 1" throwaway filter
- Riser-slot knockouts
- Supply-air knockouts

### Decorator Front Panel

- Stamped louver return-air grille
- Durable, powder-coat paint
- Quarter-turn, cam-lock fasteners

### Supply Air

- Single outlet
- Front, side or top outlets

### Coils

- Cooling: 3 or 4-row chilled water
- Heating: 1 or 2-row hot water – reheat position
- 5 total rows of cooling and heating coils maximum
- 1/2" O.D. seamless copper tubes
- 0.016" tube-wall thickness
- High-efficiency, aluminum-fin surface for optimizing heat transfer, pressure drop and carryover
- Easily removable for service
- Manual air vents

### Drain Pans

- Composite double wall, anti-microbial
- Positively sloped to drain connection
- 7/8" O.D. drain connection
- P-trap is factory-installed

### Fan Assemblies

- Forward-curved, DWDI, centrifugal-type blowers
- 115, 208-230 & 277V, single-phase, three-tap PSC motors
- Quick-disconnect motor connections
- Easily removable fan/motor deck for service

### Electrical

- cETL listed for safety compliance
- Electrical enclosure with access door for field-wiring terminations
- Terminal block for field connections

### Electric Heat

- ETL-listed as an assembly for safety compliance
- Integral electric-heat assembly with removable elements for easy service
- Automatic-reset primary and back-up secondary thermal limits
- Single-point-power connection

## OPTIONAL FEATURES:

### Construction

- Master/slave arrangements
- Foil-faced fiberglass insulation
- Elastomeric, closed-cell-foam insulation
- 1" pleated filter (MERV 6)
- Synthetic media
- Manual or motorized outside-air damper
- Blower shield

### Decorator Front Panel

- Recessing frame
- Full-faced aluminum grille

### Supply Air

- Double-deflection discharge grille(s)
- Double outlets
- Sight and sound baffles for double-outlet units
- Opposed-blade damper

### Coils

- Automatic air vents
- 0.025" tube wall
- Stainless-steel coil casings

### Drain Pans

- Stainless-steel construction with external insulation
- Removable for cleaning

### Fan Assemblies

- 115, 208-230 & 277V, single-phase, three-tap EC motors
- 115, 208-230 & 277V, single-phase, variable speed EC motors

### Electrical

- SCR fan-speed controller
- Fan-relay packages
- Silent, solid-state fan relays
- Toggle disconnect switch
- Condensate-overflow switch (drain pan)
- Main fusing
- Unit and remote-mounted, three-speed fan switches

### Electric Heat

- Manual-reset, secondary thermal limit
- Silent relay/contactors
- Door-interlocking disconnect switches
- Main fusing

### Piping Packages

- Factory-assembled and installed
- 1/2", 2-way and 3-way, normally closed, two-position, electric, motorized valves
- Stainless-steel-braided hoses (threaded swivel connections) for thermal expansion, including isolation ball valves with memory stop
- Fixed-flow and adjustable-flow control devices
- P/T ports and Y-strainers
- Modulating control valves
- High-pressure, close-off actuators (50 PSIG max)

### Thermostats

- Analog, digital display, or programmable
- Unit-mounted and wall-mounted
- 2-pipe and 4-pipe control sequences
- Automatic and manual changeover
- Integral, three-speed, fan switches
- ADA mounting location on front panel or unit sides

### Risers

- Type-M or Type-L copper with swaged connections
- 3/4" to 3" diameters
- 1/2" and 3/4" closed-cell insulation
- Type-M copper condensate riser
- Riser extensions
- Riser cover
- Ship-in-advance risers