

CATALOG

VFR Parallel Flow, Fan-Powered, 50/60 Hz VAV Terminals



TABLE OF CONTENTS

Features and Benefits 2
 Controls 4
 Construction Features 5
 Standard and Optional Features 7
 Application and Selection 8
 Dimensional Data 11
 Primary Airflow Calibration 13
 General Selection Data, 50 Hz PSC Motor 14
 Sound Power Data, Radiated, 50 Hz PSC Motor 15
 Sound Power Data, Discharge, 50 Hz PSC Motor 16
 Sound Power Data, Unit Fan, 50 Hz PSC Motor 17
 Fan Performance Data, 50 Hz PSC Motor 19
 General Selection Data, 60 Hz PSC Motor 20
 Sound Power Data, Radiated, 60 Hz PSC Motor 22
 Sound Power Data, Discharge, 60 Hz PSC Motor 23
 Sound Power Data, Unit Fan, 60 Hz PSC Motor 24
 Fan Performance Data, 60 Hz PSC Motor 26
 EC Fan Motor Option 29
 General Selection, EC Motor 30
 Fan Performance, EC Motor 31
 AHRI Ratings 32
 Electric Heat 33
 Hot Water Coil Data 34
 Guide Specifications 38

NOTES:

- All data herein is subject to change without notice.
- Construction drawings and performance data contained herein should not be used for submittal purposes.
- ETL Report Number 476203.



FEATURES AND BENEFITS

QUIET COMFORT

Model VFR fan terminals are specifically designed for quiet operation. They also offer improved space comfort and flexibility for a wide variety of HVAC systems. This is critical in today’s buildings, where occupants are placing more emphasis on indoor acoustics.

OCCUPANT-SENSITIVE DESIGN

Due to heightened interest in Indoor Air Quality, many HVAC system designers are focusing on the effects of particulate contamination within a building’s occupied space. Often, HVAC system noise is overlooked as a source of occupied space contamination. The VFR terminal is specifically designed to eliminate obtrusive fan noise from reaching the occupants.

Occupants will benefit from the VFR design that minimizes low frequency (125Hz-250Hz) sound levels that typically dominate the space sound level.

DESIGN FLEXIBILITY

Selection and Layout. The VFR provides flexibility in system design. Reduced noise at the fan terminal allows the system designer to place properly sized units directly above occupied spaces. It is not necessary to use the crowded space above a hall or corridor to locate

the equipment. This will reduce lengthy and expensive discharge duct runs. The standard shallow casing height (14" up to 1000 CFM) minimizes conflict with other systems competing for ceiling space. The FlowStar™ sensor ensures accurate control, even when space constraints do not permit long straight inlet duct runs to the terminal.

Sizes. Primary air valves and fans are available in various size combinations to provide fan capacities between 20% and 100% of the selected maximum primary airflow. Model VFR terminals are available with primary valves handling up to 4100 CFM. Six fan sizes provide a range of heating capacities between 50 and 2400 CFM.

A web-based Computer Selection Program, “Web-Select”, is available to facilitate the selection process. Contact your representative to obtain access to this powerful and time-saving program.

CONVENIENT INSTALLATION

Quality. All VFR terminals are thoroughly inspected during each step of the manufacturing process, including a comprehensive “pre-ship” inspection, to assure the highest quality product available. Each unit is also “run tested” before leaving the factory to ensure trouble free field “start-up.”

FEATURES AND BENEFITS

Quick Installation. A standard single point electrical main power connection is provided. Electronic controls and electrical components are located on the same side of the casing for quick access, adjustment, and troubleshooting. Installation time is minimized with the availability of factory calibrated controls.

Finite fan speed adjustment is accomplished with an electronic SCR controller. The SCR fan speed controller is offered by ENVIRO-TEC and is compatible with the fan motor. This minimizes electronic interference and harmonic distortion that occurs from non-compatible motor and SCR components. Increased motor life and efficiency result from the compatible design.

VFR terminals utilize three tap motors that accommodate a broad range of flow and static pressure field conditions while dramatically increasing efficiency.

The FlowStar™ sensor ensures accurate airflow measurement, regardless of the field installation conditions. A calibration label and wiring diagram is located on the terminal for quick reference during start-up.

The terminal is constructed to allow installation with standard metal hanging straps. Optional hanger brackets for use with all-thread support rods or wire hangers are also available.

VALUE AND SECURITY

Quality. All metal components are fabricated from galvanized steel. Unlike most manufacturers' terminals, the steel used in the VFR is capable of withstanding a 125 hour salt spray test without showing any evidence of red rust.

Energy Efficiency. In addition to quiet and accurate temperature control, the building owner will benefit from lower operating costs. The highly amplified velocity

pressure signal from the FlowStar™ inlet sensor allows precise airflow control at low air velocities.

The FlowStar™ sensor's airfoil shape provides minimal pressure drop across the terminal. This allows the central fan to run at a lower pressure and with less brake horsepower. Energy efficient three tap, three winding, permanent split capacitor fan motors are manufactured to ensure efficient, quiet, reliable, and low maintenance operation.

Three tap motors provide superior energy efficiency over single speed motors by delivering three separate horsepower outputs. For example, a nominal 1/2 HP motor delivers 1/3 HP on medium tap and 1/4 HP on low tap. This allows the motor to operate at a higher efficiency when at a reduced fan capacity.

Fan terminals that utilize a single speed motor must rely solely on an SCR controller to obtain the reduction in fan capacity. At minimum turndown, they suffer from excessive power consumption and high motor winding temperatures, significantly reducing the motor life.

Agency Certification. Model VFR terminals, including those with electric heat, are listed with ETL as an assembly, and bear the ETL label. VFR terminals comply with applicable NEC requirements, are tested in accordance with AHRI Standard 880, and are certified by AHRI.

Maintenance and Service. VFR fan terminals require no periodic maintenance other than optional filter replacement. If component replacement becomes necessary, the unit is designed to minimize field labor. The bottom casing panel can be removed to provide easy access to the fan assembly, and the motor electrical leads are easily unplugged. Fan access is also provided through the induction air inlet, except for hot water coil units.

CONTROLS

Model VFR terminals are available with analog electronic, consignment DDC, and pneumatic controls. ENVIRO-TEC offers a complete line of analog electronic controls specifically designed for use with VFR terminals. These controls are designed to accommodate a multitude of control schemes.

From the most basic to the most sophisticated sequence of operation, the controls are designed by experts in VAV single duct terminal operation. Refer to the Electronic Controls Selection Guide, and the Pneumatic Controls Selection Guide for a complete description of the sequences and schematic drawings that are available.

Available Control Types:

- Analog Electronic (shown)
- Pneumatic
- Factory mounted consignment DDC

Standard Features of Include:

- Patented FlowStar™ Airflow Sensor
- ETL Listing
- NEMA 1 Enclosure
- 24 Volt Control Transformer
- Floating Modulating Actuator
- Balancing Tees and Plenum Rated Tubing



CONSTRUCTION FEATURES

MODEL VFR

The VFR terminal incorporates many **standard** features are expensive options for other manufacturers.

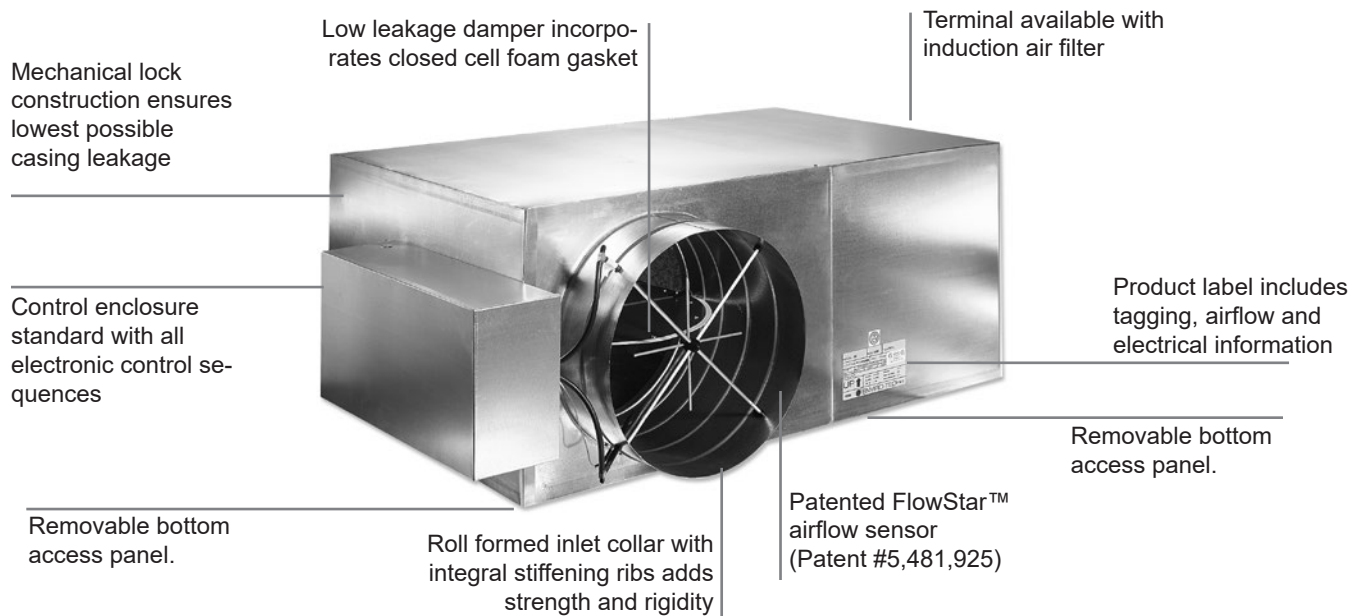
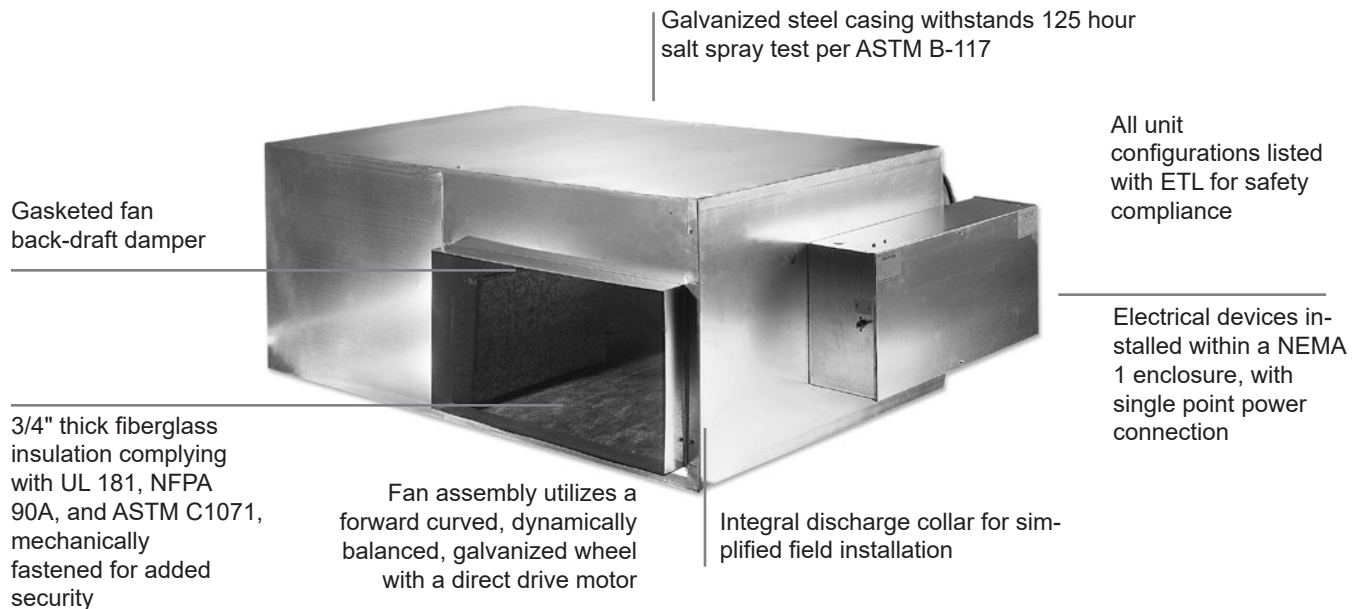

OPTIONAL CONSTRUCTION FEATURES

- Mounting brackets to accept all-thread hanging rods or wire hangers
- Double wall construction
- Scrim reinforced foil faced insulation meeting ASTM C1136 for mold, mildew, and humidity resistance
- Elastomeric closed cell foam insulation
- Hot water (VFR-WC), steam, or electric heating coils (VFR-EH).
- Factory control options: analog electronic, DDC electronic, pneumatic
- Factory piping packages
- ECM motor control

CONSTRUCTION FEATURES

ACCURATE AND ENERGY-SAVING AIRFLOW CONTROL WITH THE PATENTED FLOWSTAR™ SENSOR

Many VAV terminals waste energy due to an inferior airflow sensor design that requires the minimum CFM setpoint to be much higher than the IAQ calculation requirement. This is common with interior spaces that will be effected year round. These inferior VAV terminals waste energy in several ways. First, the primary air fan (e.g. AHU) supplies more CFM than the building requires. The higher minimum CFM setpoint overcools the zone with VAV terminals without integral heat. To maintain thermal comfort a building engineer would need to change the minimum setpoint to zero CFM compromising indoor air quality. Inferior VAV terminals with integral heat provide adequate comfort in the space but waste significant energy as energy is consumed to mechanically cool the primary air only to have more energy consumed to heat the cooled primary air. Significant energy savings is obtained with proper sizing and by making sure approved VAV terminals are capable of controlling at low CFM setpoints, providing the minimum ventilation requirement.

Currently, most DDC controllers have a minimum differential pressure limitation between 0.015" and 0.05" w.g. The major DDC manufacturers can control down to 0.015" w.g. An airflow sensor that does not amplify, e.g., a Pitot tube, requires about 490 FPM to develop 0.015" w.g. differential pressure. The FlowStar™ develops 0.015" w.g. pressure with only 290 FPM on a size 6 terminal and less than 325 FPM for a size 16. Consequently, VAV terminals utilizing a non-amplifying type sensor could have minimum CFM's that are well over 50% higher than an ENVIRO-TEC terminal. Many airflow sensors provide some degree of amplification simply due to the decrease in free area of the inlet from large area of the sensor. These VAV terminals still require minimum CFM's up to 30% higher than an ENVIRO-TEC terminal, have higher sound levels, and higher pressure drop requiring additional energy consumption at the primary air fan.

A VAV system designed with ENVIRO-TEC terminals consumes significantly less energy than a comparable system with competitor's terminals. The FlowStar™

airflow sensor reduces energy consumption by allowing lower zone minimum CFM setpoints, greatly reducing or eliminating "reheat", and by imposing less resistance on the primary air fan.

The ENVIRO-TEC air valve features the FlowStar™ airflow sensor which has brought new meaning to airflow control accuracy. The multi-axis design utilizes between 12 and 20 sensing points that sample total pressure at center points within equal concentric cross-sectional areas, effectively traversing the air stream in two planes. Each distinct pressure reading is averaged within the center chamber before exiting the sensor to the controlling device.

This sensor adds a new dimension to signal amplification. Most differential pressure sensors provide a signal between .5 and 2 times the equivalent velocity pressure signal. The FlowStar™ provides a differential pressure signal that is 2.5 to 3 times the equivalent velocity pressure signal. This amplified signal allows more accurate and stable airflow control at low airflow capacities. Low airflow control is critical for indoor air quality, reheat minimization, and preventing over cooling during light loads.

Unlike other sensors which use a large probe surface area to achieve signal amplification, the FlowStar™ utilizes an unprecedented streamline design which generates amplified signals unrivaled in the industry. The streamlined design also generates less pressure drop and noise.

The VAV schedule should specify the minimum and maximum airflow setpoints, maximum sound power levels, and maximum air pressure loss for each terminal. The specification for the VAV terminal must detail the required performance of the airflow sensor. For maximum building occupant satisfaction, the VAV system designer should specify the airflow sensor as suggested in the Guide Specifications of this catalog.

FlowStar™ Airflow Sensor Patent #5,481,925

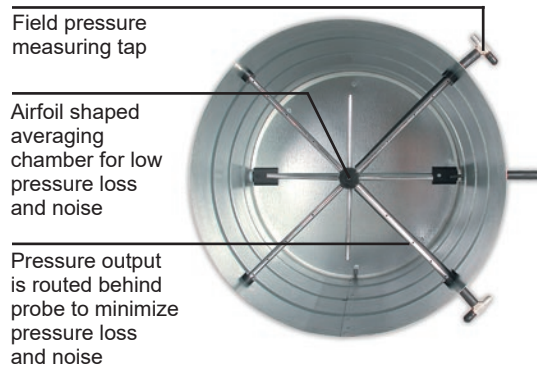
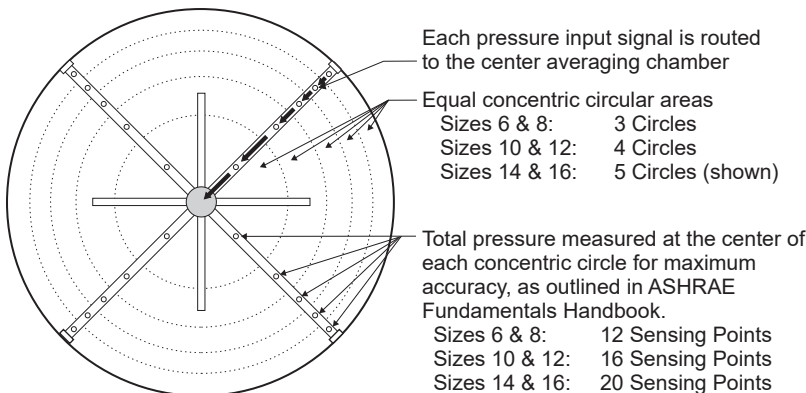

STANDARD AND OPTIONAL FEATURES

STANDARD FEATURES

Construction

- AHRI 880 certified and labeled
- 20 gauge galvanized steel casing and 22 gauge air valve
- 3/4" thick fiberglass insulation
- Large access openings allowing removal of complete fan assembly for all heating coil options

Fan Assembly

- Forward curved, dynamically balanced, direct drive, galvanized blower wheel
- 115 or 277 volt single phase, three tap PSC motor
- SCR fan speed controller
- Quick-select motor speed terminal
- Permanently lubricated motor bearings
- Thermally protected motor
- Vibration isolation motor mounts
- Single point wiring

Primary Air Valve

- Embossed rigidity rings
- Low thermal conductance damper shaft
- Position indicator on end of damper shaft
- Mechanical stops for open and closed position
- FlowStar™ center averaging airflow sensor
- Balancing tees
- Plenum rated sensor tubing

Hot Water Coils

- Designed and manufactured by ENVIRO-TEC
- AHRI 410 certified and labeled
- 1, 2, 3, 4 row coils
- Tested at a minimum of 450 PSIG under water and rated at 300 PSIG working pressure at 200°F

Electrical

- cETL listed for safety compliance
- NEMA 1 wiring enclosure

Electric Heat

- cETL listed as an assembly for safety compliance per UL 1995
- Integral electric heat assembly
- Automatic reset primary and back-up secondary thermal limits
- Single point power connection
- Hinged electrical enclosure door
- Fusing per NEC

OPTIONAL FEATURES

Construction

- 1" insulation
- Foil faced scrim backed insulation
- 1/2" thick elastomeric closed cell foam insulation
- Double wall construction with 22 gauge liner
- 1" filter rack with throwaway filter

Fan Assembly

- 208, 230, 240 and 480 volt single phase, PSC motor
- 220-240 volt 50 Hz motor
- 120, 208, 240 and 277 volt ECM fan motor

Electrical

- Full unit toggle disconnect
- Inline motor fusing
- Primary and secondary transformer fusing

Electric Heat

- Proportional (SSR) heater control
- Door interlocking disconnect switches

Controls

- Factory provided controls include:
 - Analog electronic
 - Pneumatic
- Consignment DDC controls (factory mount and wire controls provided by others)

Piping Packages

- Factory assembled – shipped loose for field installation
- 1/2" and 3/4", 2 way, normally closed, two position electric motorized valves
- Isolation ball valves with memory stop
- Fixed and adjustable flow control devices
- Unions and P/T ports
- Floating point modulating control valves
- High pressure close-off actuators (1/2" = 50 PSIG; 3/4" = 25 PSIG)

APPLICATION AND SELECTION

PURPOSE OF PARALLEL FLOW FAN TERMINALS

Parallel flow fan powered terminals offer improved space comfort and flexibility in a wide variety of applications. Substantial operating savings can be realized through the recovery of waste heat, and night setback operation.

Heat Recovery. The VFR recovers heat from lights and core areas to offset heating loads in perimeter zones. Additional heat is available at the terminal unit using electric, steam, or hot water heating coils. Controls are available to energize remote heating devices such as wall fin, fan coils, radiant panels, and roof load plenum unit heaters.

Typical Sequences of Operation. The VFR provides variable volume, constant temperature air in the cooling mode, and constant volume, variable temperature air in the heating mode.

At the design cooling condition, the primary air valve is handling the maximum scheduled airflow capacity while the unit fan is off. As the cooling load decreases, the primary air valve throttles toward the minimum scheduled airflow capacity. A further decrease in the cooling load causes the unit fan to start, inducing warm air from the ceiling plenum which increases the discharge air temperature to the zone. When the heating load increases, the optional hot water coil or electric heater is energized to maintain comfort conditions.

IAQ. The VFR enhances the indoor air quality of a building by providing higher air volumes in the heating mode than typically provided by straight VAV single duct terminals. The higher air capacity provides greater air motion in the space and lowers the heating discharge air temperature. This combination improves air circulation,

preventing accumulation of CO² concentrations in stagnant areas. Increased air motion improves occupant comfort. The higher air capacity also improves the performance of diffusers and minimizes diffuser “dumping”.

ACOUSTICAL CONCEPTS

The focus on indoor air quality is also having an effect on proper selection of air terminal equipment with respect to acoustics.

Sound Paths. At the zone level, the terminal unit generates acoustical energy that can enter the zone along two primary paths. First, sound from the unit fan can propagate through the downstream duct and diffusers before entering the zone (referred to as Discharge or Airborne Sound). Acoustical energy is also radiated from the terminal casing and travels through the ceiling cavity and ceiling system before entering the zone (referred to as Radiated Sound).

Sound Power. To properly quantify the amount of acoustical energy emanating from a terminal unit at a specific operating condition (i.e. CFM and static pressure), manufacturers must measure and publish sound power levels.

The units of measurement, decibels, actually represent units of power (watts). The terminal equipment sound power ratings provide a consistent measure of the generated sound independent of the environment in which the unit is installed. This allows a straight forward comparison of sound performance between equipment manufacturers and unit models.

Noise Criteria (NC). The bottom line acoustical criteria for most projects is the NC (Noise Criteria) level. This NC level is derived from resulting sound pressure levels in the zone. These sound pressure levels are the effect of acoustical energy (sound power levels) entering the zone caused by the terminal unit and other sound generating sources (central fan system, office equipment, outdoor environment, etc.).

The units of measurement is once again decibels; however, in this case decibels represent units of pressure (Pascals), since the human ear and microphones react to pressure variations.

There is no direct relationship between sound power levels and sound pressure levels. Therefore, we must predict the resulting sound pressure levels (NC levels) in the zone based in part by the published sound power levels of the terminal equipment. The NC levels are totally dependent on the project specific design, archi-

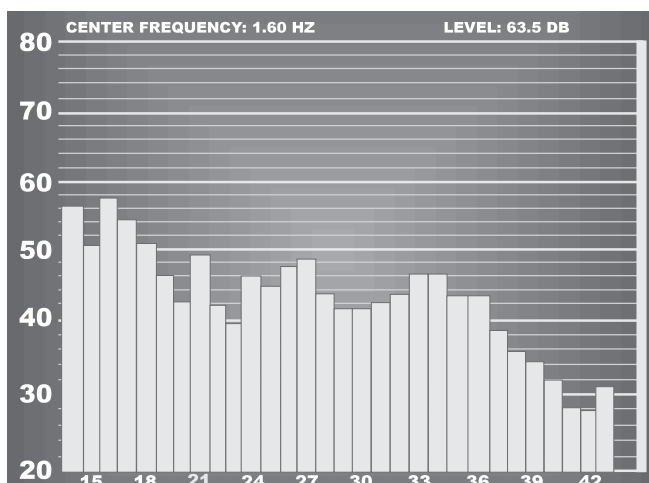

APPLICATION AND SELECTION

tecturally and mechanically. For a constant operating condition (fixed sound power levels), the resulting NC level in the zone will vary from one project to another.

AHRI 885. A useful tool to aid in predicting space sound pressure levels is an application standard referred to as AHRI Standard 885. This standard provides information (tables, formulas, etc.) required to calculate the attenuation of the ductwork, ceiling cavity, ceiling system, and conditioned space below a terminal unit. These attenuation values are referred to as the "transfer function" since they are used to transfer from the manufacturer's sound power levels to the estimated sound pressure levels resulting in the space below, and/or served by the terminal unit. The standard does not provide all of the necessary information to accommodate every conceivable design; however, it does provide enough information to approximate the transfer function for most applications. Furthermore, an Appendix is provided that contains typical attenuation values. Some manufacturers utilize different assumptions with respect to a "typical" project design; therefore, cataloged NC levels should not be used to compare acoustical performance. Only certified sound power levels should be used for this purpose.

GENERAL DESIGN RECOMMENDATIONS FOR A QUIET SYSTEM

The AHU. Sound levels in the zone are frequently impacted by central fan discharge noise that either breaks out (radiates) from the ductwork or travels through the distribution ductwork and enters the zone as airborne (discharge) sound. Achieving acceptable sound levels in the zone begins with a properly designed central fan system which delivers relatively quiet air to each zone.

Supply Duct Pressure. One primary factor contributing to noisy systems is high static pressure in the primary air duct. This condition causes higher sound levels from the central fan and also higher sound levels from the terminal unit, as the primary air valve closes to reduce the pressure. This condition is compounded when flexible duct is utilized at the terminal inlet, which allows the central fan noise and air valve noise to break out into the ceiling cavity and then enter the zone located below the terminal. Ideally, the system static pressure should be reduced to the point where the terminal unit installed on the duct run associated with the highest pressure drop has the minimum required inlet pressure to deliver the design airflow to the zone. For systems that will have substantially higher pressure variances from one zone to another, special attention should be paid to the proper selection of air terminal equipment.

To date, the most common approach has been to select (size) all of the terminals based on the worst case (highest inlet static pressure) condition. Typically, this results in 80% (or higher) of the terminal units being oversized for their application. This in turn results in much higher equipment costs, but more importantly, drastically reduced operating efficiency of each unit. This consequently decreases the ability to provide comfort control in the zone. In addition, the oversized terminals cannot adequately control the minimum ventilation capacity required in the heating mode.

A more prudent approach is to utilize a pressure reducing device upstream of the terminal unit on those few zones closest to the central fan. This device could simply be a manual quadrant type damper if located well upstream of the terminal inlet. In tight quarters, perforated metal can be utilized as a quiet means of reducing system pressure. This approach allows all of the terminal units to experience a similar (lower) inlet pressure. They can be selected in a consistent manner at lower inlet pressure conditions that will allow more optimally sized units.

Inlet Duct Configuration. Inlet duct that is the same size as the inlet collar and as straight as possible will achieve the best acoustical performance. For critical applications, flexible duct should not be utilized at the terminal inlet.

Downstream Duct Design. On projects where internal lining of the downstream duct is not permitted, special considerations should be made to assure acceptable noise levels will be obtained. In these cases, a greater number of smaller zones will help in reducing sound levels. Where possible, the first diffuser takeoff should be located after an elbow or tee and a greater number of small necked diffusers should be utilized, rather than fewer large necked diffusers.

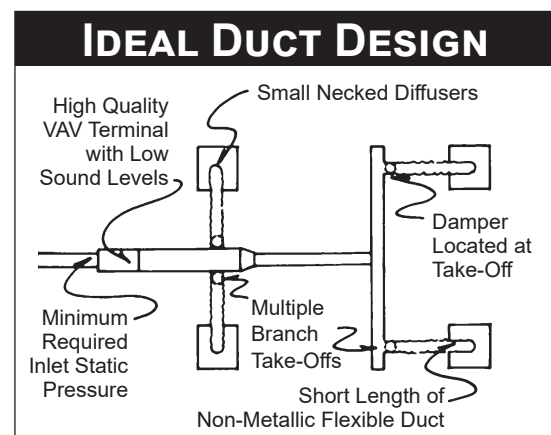

APPLICATION AND SELECTION

The downstream ductwork should be carefully designed and installed to avoid noise regeneration. Bull head tee arrangements should be located sufficiently downstream of the terminal discharge to provide an established flow pattern downstream of the fan. Place diffusers downstream of the terminal after the airflow has completely developed.

Downstream splitter dampers can cause noise problems if placed too close to the terminal, or when excessive air velocities exist. If tee arrangements are employed, volume dampers should be used in each branch of the tee, and balancing dampers should be provided at each diffuser tap. This arrangement provides maximum flexibility in quiet balancing of the system. Casing radiated sound usually dictates the overall room sound levels directly below the terminal. Because of this, special consideration should be given to the location of these terminals as well as to the size of the zone. Larger zones should have the terminal located over a corridor or open plan office space and not over a small confined private office. Fan powered terminals should never be installed over small occupied spaces where the wall partitions extend from slab-to-slab (i.e. fire walls or privacy walls).

Fan Terminal Isolation. Model VFR fan terminals are equipped with sufficient internal vibration dampening means to prevent the need for additional external isolation. Flexible duct connectors at the unit discharge typically do more harm than good. The sagging membrane causes higher air velocities and turbulence, which translates into noise. Furthermore, the discharge noise breaks out of this fitting more than with a hard sheet metal fitting.

SELECTION GUIDELINES

The VFR product line has been designed to provide maximum flexibility in matching primary air valve capacities (cooling loads) with unit fan capacities (heating loads). The overall unit size is dictated by the primary air valve sizes (cooling design capacity). With each unit size, various fan sizes are available to handle a wide range of fan capacities from relatively low heating airflow capacities (i.e. 25% of maximum primary capacity) all the way up to relatively high heating airflow capacities (i.e. 100% of maximum primary).

The primary air valve should be sized first to determine the unit size. Typically, the primary air valve sound is insignificant relative to the unit fan sound performance. The selection process typically involves choosing an air valve size that is as small as possible while yielding acceptable sound levels and pressure drop. For non-

acoustically sensitive applications such as shop-ping malls and airports, the primary air valve can be sized at the maximum rated capacity.

After the primary air valve has been selected, the fan can be selected from the various sizes available for that unit size. The selection is made by cross plotting the specified fan capacity and external static pressure on the appropriate fan performance curves. Terminals utilizing hot water heating coils require the summation of the coil air pressure drop and the design E.S.P. to determine the total E.S.P. It is common to have more than one fan size which can meet the design requirements. Typically, the selection begins with the smallest fan that can meet the capacity. Occasionally, this selection may not meet the acoustical requirements and thus, the next larger fan size would be selected.

Fan selections can be made anywhere in the non-shaded areas. Each fan performance curve depicts the actual performance of the relative motor tap without any additional fan balance adjustment. Actual specified capacities which fall below a particular fan curve (low, medium, or high) is obtained by adjustment of the electronic (SCR) fan speed controller.

SYSTEM PRESSURE CONSIDERATIONS

The central fan is required to produce sufficient inlet static pressure to force the air through the primary air valve, unit casing, downstream ductwork and fittings, and diffusers with the unit fan off. The VFR has been designed to reduce central fan power consumption by placing the optional hot water heating coil in the induction air stream, eliminating the coil from these central system pressure considerations.

The industry standard for testing and rating air terminal units (AHRI 880) requires that published pressure drop performance be measured with hard, straight, unlined duct entering and leaving the terminal unit. On many projects, due to the limited available space, terminal units are not installed in this optimum manner. Frequently, flexible duct is used at the terminal inlet and a metal transition is utilized at the discharge. The entrance and exit losses in these instances exceed the actual terminal unit pressure loss. It is important to consider terminal unit pressure loss as well as those losses associated with the entire distribution ductwork (as outlined in applicable ASHRAE Handbooks) when sizing central system fan requirements.

A computer selection program is also available for complete VFR automated selection.

DIMENSIONAL DATA

MODEL VFR

Drawings are not to scale and not for submittal or installation purposes.

UNIT SIZE	A	B	C	I	X	Y	W	H	L
0404	10 1/2 [267]	5 [127]	7 [178]	3 7/8 [98]	8 [203]	7 [178]	29 [737]	14 [356]	23 1/2 [597]
0504	10 1/2 [267]	5 [127]	7 [178]	4 7/8 [124]	8 [203]	7 [178]			
0604	6 1/2 [165]	5 [127]	7 [178]	5 7/8 [149]	8 [203]	7 [178]			
0606	6 1/2 [165]	5 [127]	7 [178]	5 7/8 [149]	8 [203]	7 [178]			
0804	6 1/2 [165]	6 [152]	7 [178]	7 7/8 [200]	11 [279]	7 [178]	37 [940]	17 [432]	29 1/2 [749]
0806									
0811									
1006	6 1/2 [165]	7 [178]	8 1/2 [216]	9 7/8 [251]	14 [356]	10 [254]			
1011									
1018									
1211	6 1/2 [165]	8 [203]	8 1/2 [216]	11 7/8 [302]	16 [406]	10 [254]			
1218									
1221									
1411	6 1/2 [165]	9 [229]	9 1/2 [241]	13 7/8 [352]	22 [559]	12 [305]	45 [1143]	19 [483]	29 1/2 [749]
1418									
1421									
1424									
1621	6 1/2 [165]	10 [254]	9 1/2 [241]	15 7/8 [403]	24 [610]	12 [305]	45 [1143]	19 [483]	29 1/2 [749]
1624	6 1/2 [165]	10 [254]	9 1/2 [241]	15 7/8 [403]	24 [610]	12 [305]	49 [1245]		

Top View

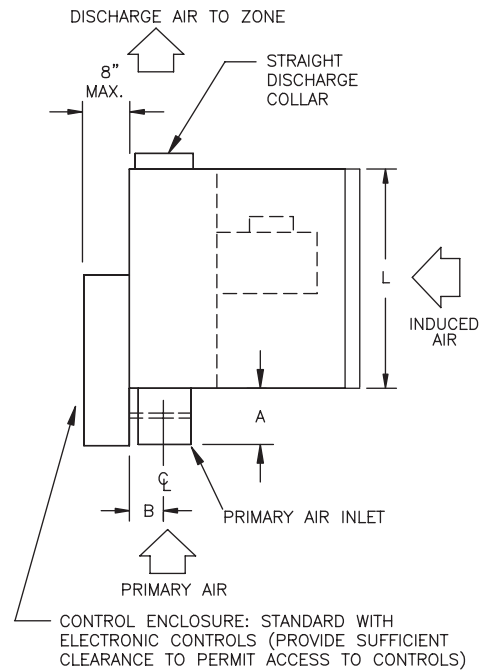

Discharge Collar Detail

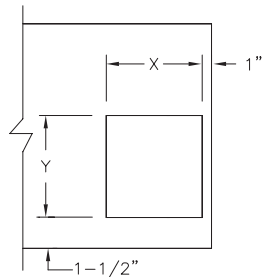

Side View

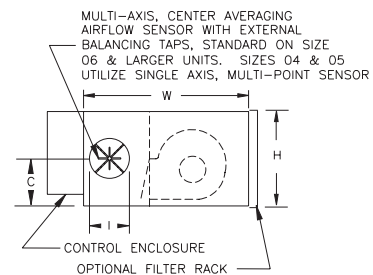

MODEL VFR-WC (HOT WATER COIL)

Hot Water Coil Detail (End View)

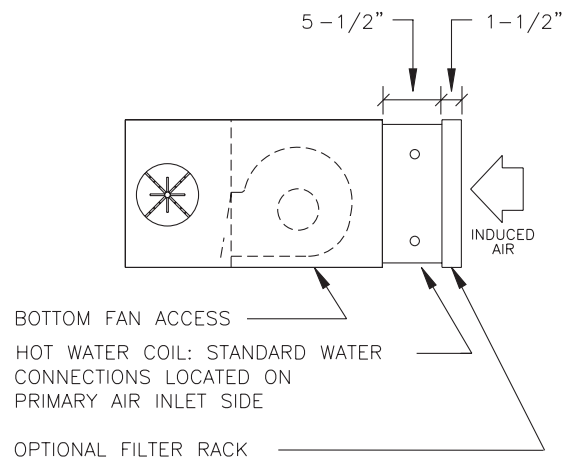

DIMENSIONAL DATA

MODEL VFR-EH (ELECTRIC HEAT)

Drawings are not to scale and not for submittal or installation purposes.

Discharge Collar Detail

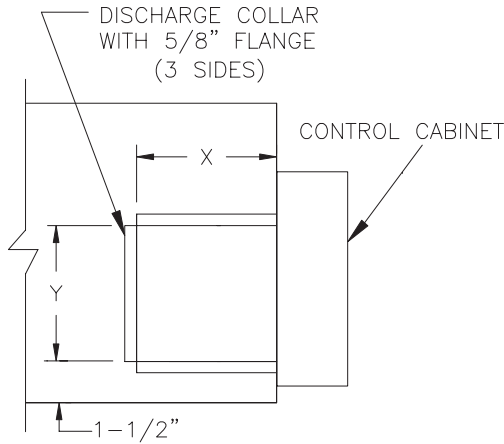

Electric Heater Detail (Top View)

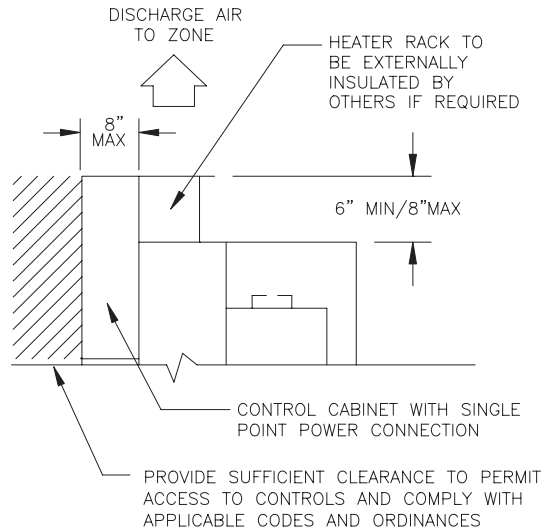

MODEL VFR ARRANGEMENTS

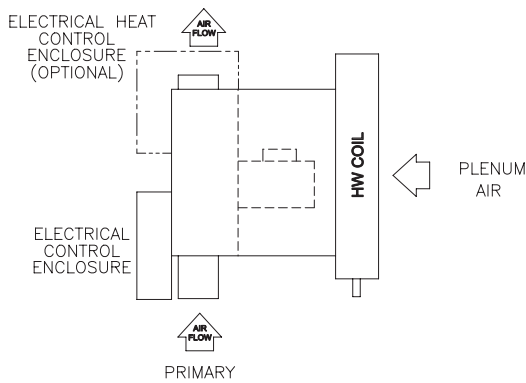

ARRANGEMENT 1
LEFT HAND CONTROL UNIT WITH LEFT HAND COIL

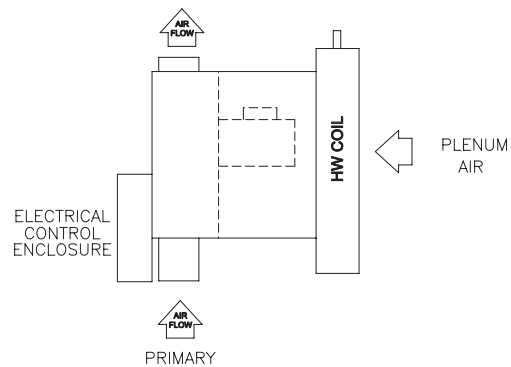

ARRANGEMENT 2
LEFT HAND CONTROL UNIT WITH RIGHT HAND COIL

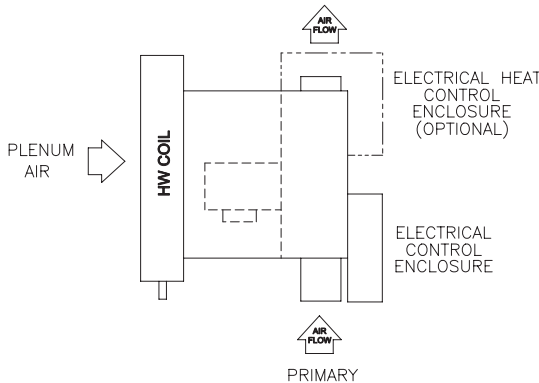

ARRANGEMENT 3
RIGHT HAND CONTROL UNIT WITH RIGHT HAND COIL

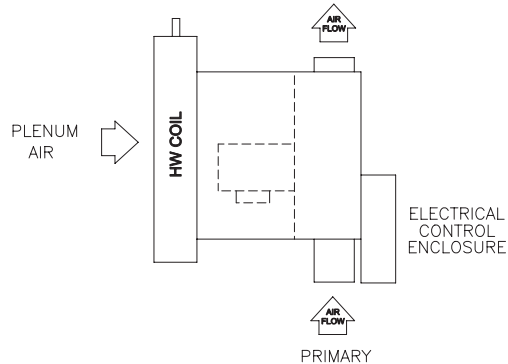

ARRANGEMENT 4
RIGHT HAND CONTROL UNIT WITH LEFT HAND COIL

PRIMARY AIRFLOW CALIBRATION

FLOWSTAR™ CALIBRATION CHART (For dead-end differential pressure transducers)

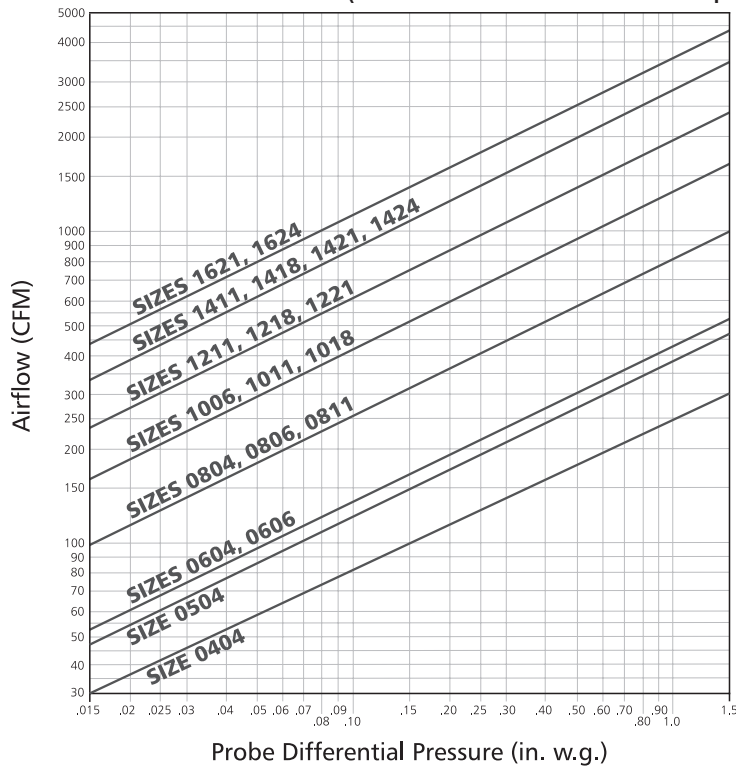

NOTE: Maximum and minimum CFM limits are dependent on the type of controls that are utilized. Refer to the table below when the controls are furnished by ENVIRO-TEC. When DDC controls are furnished by others, the CFM limits are dependent on the specific control vendor that is employed. After obtaining the differential pressure range from the control vendor, the maximum and minimum CFM limits can be obtained from the chart (many controllers are capable of controlling minimum setpoint down to .015" w.g.).

AIRFLOW RANGES (CFM)

UNIT SIZE	400 SERIES (PNEUMATIC) STANDARD CONTROLLER		7000 SERIES ANALOG ELECTRONIC		DDC CONSIGNMENT CONTROLS (See Note 1 Below)				
	MIN.	MAX.	MIN.	MAX.	MIN.			MAX.	
					Min. transducer differential pressure (in.w.g.)			Max. transducer differential pressure (in.w.g.)	
					.015	.03	.05	1.0	≥1.5
0404	43	250	35	250	30	43	55	250	250
0504	68	350	50	350	48	68	88	350	350
0604, 0606	75	490	60	550	53	75	97	435	530
0804, 0806, 0811	145	960	115	1000	105	145	190	840	1000
1006, 1011, 1018	235	1545	185	1600	165	235	305	1355	1600
1211, 1218, 1221	340	2250	285	2300	240	340	440	1975	2300
1411, 1418, 1421, 1424	475	3100	390	3100	335	475	615	2750	3100
1621, 1624	625	4100	520	4100	440	625	805	3595	4100

NOTES:

1. Minimum and maximum airflow limits are dependent on the specific DDC controller supplied. Contact the control vendor to obtain the minimum and maximum differential pressure limits (inches W.G.) of the transducer utilized with the DDC controller.
2. Maximum CFM is limited to value shown in General Selection Data.

GENERAL SELECTION DATA, 50 HZ PSC MOTOR

PRIMARY AIR VALVE

UNIT SIZE	CFM	MIN. DP _s (IN. W.G.)	ROOM NOISE CRITERIA (NC)					
			0.5" W.G. DP _s		1.0" W.G. DP _s		3.0" W.G. DP _s	
			Dis.	Rad.	Dis.	Rad.	Dis.	Rad.
0606	200	.03	--	--	--	--	22	22
	250	.04	--	--	--	--	22	24
	300	.06	--	--	--	--	22	25
	350	.08	--	--	20	20	25	28
	450	.14	23	22	26	25	30	32
	550	.21	28	29	32	29	35	34
0806	300	.01	--	--	--	--	--	29
	400	.03	--	--	--	20	24	32
	500	.04	--	--	21	23	27	33
	600	.06	--	22	23	25	31	35
	800	.10	23	27	27	30	34	38
0811	1000	.15	28	32	32	35	36	40
	600	.01	--	--	--	24	27	32
	800	.01	--	23	--	27	28	35
	1000	.01	--	25	22	29	31	37
	1200	.02	20	29	23	32	33	40
1006	1400	.02	24	33	27	33	36	42
	1600	.03	28	34	30	35	37	44
	800	.01	--	20	--	24	27	34
	1100	.02	--	24	22	28	30	37
1211	1400	.04	--	28	26	32	34	40
	1700	.06	22	32	29	34	40	45
	2000	.08	26	35	32	38	42	48
	2300	.10	29	37	35	40	46	50
	1100	.02	--	--	20	23	29	33
1411	1500	.04	--	22	25	28	34	40
	1900	.06	--	24	29	33	38	44
	2300	.08	23	28	32	37	43	47
1421	2700	.12	27	30	33	38	48	50
	3100	.15	30	33	35	42	52	52
	1600	.01	--	24	21	33	31	42
1621	2100	.02	21	28	28	37	35	47
	2600	.03	26	30	33	39	40	49
	3100	.04	29	35	38	42	45	50
	3600	.05	30	37	41	43	49	54
	4100	.07	31	38	43	45	56	57

FAN

UNIT SIZE	CFM	ROOM NOISE CRITERIA (NC)	
		Discharge	Radiated
		0606	300
400	--		34
500	24		37
0806	300	--	27
	400	--	34
	500	21	37
1006	300	--	27
	400	--	34
	500	20	37
0811	400	--	29
	700	--	33
	1000	25	39
	400	--	29
1011	700	--	33
	1000	23	39
	400	--	29
1211	700	--	33
	1000	21	39
	400	--	29
1411	700	--	33
	1000	21	39
	800	--	33
1018	1100	--	35
	1400	23	37
	1800	30	43
	800	--	33
1218	1100	--	35
	1400	23	37
	1800	29	43
	800	--	33
1418	1100	--	35
	1400	20	37
	1800	29	43
	1200	20	34
1221	1600	26	38
	2000	30	43
	1200	--	34
1421	1600	24	38
	2000	28	43
	1200	--	34
1621	1600	24	38
	2000	28	43
	1500	20	35
1424	1900	24	39
	2400	30	44
	1500	20	35
1624	1900	24	39
	2400	29	44

NOTES:

- Min. ΔP_s is the static pressure difference between the terminal inlet and discharge with the damper wide open. Terminals equipped with electric heat (Model VFR-EH) require the addition of the heater pressure drop (see page 22) to determine the cumulative minimum ΔP_s for the unit.
- Performance data obtained from tests conducted in accordance with AHRI Standard 880.
- Dash (-) indicates NC level less than 20.
- NC values are calculated using attenuation values provided in appendix E of AHRI 885-2008, as shown below.
- NC (sound pressure) levels predicted by subtracting appropriate values below from published sound power levels (following pages).

HORSEPOWER / AMPERAGE DATA

UNIT SIZE	FAN HORSEPOWER			AMPERAGE		
				220V		
	LOW	MED	HI	LOW	MED	HI
0606, 0806, 1006	1/10	1/8	1/6	0.7	0.8	1.0
0811, 1011, 1211, 1411	1/6	1/5	1/4	1.0	1.1	1.6
1018, 1218, 1418	1/4	1/3	1/2	1.5	1.9	3.0
1221, 1421, 1621	1/3	1/2	5/8	2.1	3.4	3.6
1424, 1624	1/2	3/4	1	1.8	2.7	4.0

DISCHARGE ATTENUATION VALUES	OCTAVE BAND						
	2	3	4	5	6	7	
Small Box (< 300 CFM)	24	28	39	53	59	40	
Medium Box (300-700 CFM)	27	29	40	51	53	39	
Large Box (> 700 CFM)	29	30	41	51	52	39	
RADIATED ATTENUATION VALUES	OCTAVE BAND						
	2	3	4	5	6	7	
Type 2 - Mineral Fiber Ceiling	18	19	20	26	31	36	

A web-based Computer Selection Program, "Web-Select", is available to facilitate the selection process. Contact your representative to obtain access to this powerful and time-saving program.

SOUND POWER DATA, 50 HZ PSC MOTOR

PRIMARY AIR VALVE, RADIATED

UNIT SIZE	CFM	0.5" W.G. DP _s							1.0" W.G. DP _s							1.5" W.G. DP _s							3.0" W.G. DP _s						
		OCTAVE BAND NUMBER							OCTAVE BAND NUMBER							OCTAVE BAND NUMBER							OCTAVE BAND NUMBER						
		2	3	4	5	6	7	2	3	4	5	6	7	2	3	4	5	6	7	2	3	4	5	6	7	2	3	4	5
0606	200	47	40	37	32	27	28	51	44	41	35	29	28	52	46	43	36	30	29	57	51	48	41	34	32				
	250	49	42	39	34	29	28	53	46	43	36	30	28	54	48	45	38	31	29	59	53	50	42	35	32				
	300	52	45	41	36	30	28	56	47	44	38	31	28	58	49	46	39	32	29	62	55	51	43	36	33				
	350	55	47	43	37	32	29	57	49	46	39	33	29	59	51	48	40	34	30	64	57	52	44	37	33				
	400	57	50	44	38	32	29	60	52	48	40	34	30	62	54	50	42	36	31	66	58	54	46	38	34				
	450	59	52	46	39	33	29	62	54	49	42	36	31	63	56	50	43	37	32	67	60	55	47	40	35				
550	65	56	50	42	35	31	65	57	52	43	37	32	66	58	53	44	38	33	69	62	57	48	41	36					
0806 0811	300	51	43	39	33	28	26	57	50	45	37	31	28	58	52	47	40	33	30	62	57	54	47	38	35				
	400	53	45	40	35	29	27	58	51	46	39	32	29	60	54	49	41	34	31	65	61	57	48	40	36				
	500	56	47	42	36	31	28	60	52	47	40	34	30	62	54	50	42	36	32	66	62	58	49	41	37				
	600	59	49	44	37	33	29	62	53	48	41	36	31	64	56	51	43	39	33	68	64	59	50	43	38				
	700	61	51	46	38	34	30	64	54	49	42	38	32	66	58	52	45	40	33	70	66	60	50	44	38				
	800	63	53	47	40	36	30	66	56	50	44	39	32	67	59	52	46	40	34	71	67	60	51	45	39				
	1000	67	57	51	43	38	32	70	60	54	46	41	34	71	62	56	48	42	36	74	69	61	52	46	41				
1006 1011 1018	600	57	48	41	34	29	27	61	52	46	38	32	29	62	54	48	40	34	30	67	60	56	48	39	35				
	800	60	51	44	37	31	28	63	54	48	40	33	30	65	56	50	42	35	32	70	62	58	50	41	38				
	1000	62	52	45	39	33	29	65	56	50	43	37	34	66	58	52	45	38	35	71	64	59	51	43	39				
	1100	64	54	46	40	34	30	66	57	51	44	38	35	68	60	54	46	40	38	72	64	60	52	44	41				
	1200	65	55	48	41	35	32	67	58	52	45	39	36	69	60	54	47	41	38	74	65	60	52	46	43				
	1400	68	58	51	44	38	34	68	60	54	46	40	37	70	62	56	48	42	39	75	67	61	54	47	46				
1600	69	60	52	45	39	35	70	62	56	48	42	38	72	64	58	50	44	40	77	68	62	55	49	47					
1211 1218 1221	800	58	48	42	36	29	27	61	53	47	39	33	30	63	56	50	41	35	32	68	63	57	48	42	39				
	1100	61	52	46	38	31	28	64	55	49	41	35	31	66	58	52	43	37	33	71	65	59	50	44	40				
	1400	64	56	48	40	33	29	67	58	52	43	37	33	69	60	54	45	39	35	74	67	61	52	45	41				
	1600	66	58	51	42	35	30	68	60	53	45	38	34	71	63	60	53	47	37	77	68	62	53	47	42				
	1700	67	59	52	43	36	31	69	61	54	46	39	35	72	64	60	53	47	37	78	69	63	54	47	43				
	2000	70	61	54	46	38	33	72	63	57	48	41	36	74	65	61	54	48	38	80	71	64	55	49	45				
2300	71	63	56	47	40	35	74	65	59	50	43	38	76	67	61	54	49	40	82	72	66	57	51	47					
1411 1418 1421 1424	1100	55	46	41	34	28	28	60	52	46	38	31	30	62	54	48	40	33	32	68	62	56	46	40	38				
	1500	59	49	43	36	30	29	64	55	48	40	33	31	66	58	51	42	35	33	74	66	59	50	42	39				
	1900	61	52	45	38	32	30	68	57	49	42	35	33	70	60	52	44	38	35	77	68	61	51	45	42				
	2100	62	53	46	39	33	30	70	58	50	43	36	34	73	61	54	46	40	38	78	68	62	52	46	42				
	2300	64	54	47	40	34	31	71	59	51	44	38	35	73	62	54	46	40	39	79	69	62	52	46	43				
	2700	66	56	49	42	36	33	72	61	53	46	40	38	74	63	56	48	42	40	82	70	63	54	48	46				
3100	68	58	51	44	38	34	75	62	55	47	42	40	77	64	57	49	44	42	83	71	63	55	49	47					
1621 1624	1600	61	53	47	37	30	28	68	60	53	43	36	32	70	62	55	45	38	34	75	69	62	52	45	42				
	2100	64	56	49	42	34	31	71	62	55	46	39	35	73	65	58	48	42	38	79	73	66	56	49	45				
	2600	66	58	51	43	37	33	73	64	56	48	40	36	75	66	59	50	42	38	81	74	67	57	50	46				
	2800	68	59	52	43	37	33	74	64	57	49	41	36	77	68	61	52	44	40	81	75	67	58	50	46				
	3100	70	60	53	44	38	34	75	65	58	50	42	37	78	68	61	53	44	40	82	76	68	59	51	47				
	3600	71	61	54	46	39	35	76	66	59	51	43	39	78	69	62	54	45	41	84	77	69	61	52	48				
4100	72	63	57	48	40	36	78	68	60	52	44	40	80	70	62	54	47	43	86	78	70	62	55	51					

NOTES:

- Data obtained from tests conducted in accordance with AHRI Standard 880.
- Sound levels are expressed in decibels, dB re: 1 x 10⁻¹² Watts.
- ΔP_s is the difference in static pressure across the primary air valve.
- Certified AHRI data is highlighted blue. Application data (not highlighted blue) is outside the scope of the certification program.

A web-based Computer Selection Program, "Web-Select", is available to facilitate the selection process. Contact your representative to obtain access to this powerful and time-saving program.

SOUND POWER DATA, 50 Hz PSC MOTOR

PRIMARY AIR VALVE, DISCHARGE

UNIT SIZE	CFM	0.5" W.G. DPs							1.0" W.G. DPs							1.5" W.G. DPs							3.0" W.G. DPs						
		OCTAVE BAND NUMBER							OCTAVE BAND NUMBER							OCTAVE BAND NUMBER							OCTAVE BAND NUMBER						
		2	3	4	5	6	7	2	3	4	5	6	7	2	3	4	5	6	7	2	3	4	5	6	7				
0606	200	57	49	43	34	30	29	59	54	47	40	34	34	60	55	49	43	36	36	63	59	54	51	44	44				
	250	59	52	44	36	31	30	61	56	48	41	34	34	62	57	50	44	36	36	66	62	56	52	44	44				
	300	62	54	46	38	31	30	64	58	50	42	35	35	65	59	52	45	38	38	68	64	57	52	45	45				
	350	65	56	48	39	34	33	67	61	52	44	37	37	68	62	54	46	39	39	71	66	60	53	45	45				
	400	68	59	50	41	36	35	70	63	54	45	39	38	71	65	56	48	42	42	73	68	62	54	46	46				
	450	70	61	53	44	38	37	72	64	56	47	41	40	73	65	58	49	42	42	75	70	63	55	47	47				
550	74	64	56	48	41	40	77	69	60	51	45	44	78	70	62	53	46	46	79	73	66	58	50	50					
0806 0811	300	57	50	44	38	33	31	61	56	49	44	38	37	62	57	51	48	41	40	66	61	59	58	49	48				
	400	60	53	47	41	36	32	65	58	51	46	41	40	66	60	54	49	43	42	70	65	62	59	50	50				
	500	63	55	49	43	38	35	67	60	53	47	43	41	68	62	55	50	45	44	72	67	63	60	51	51				
	600	66	58	51	45	40	38	69	63	56	49	45	43	70	65	58	52	47	45	75	70	64	61	53	52				
	700	68	60	53	46	42	40	72	65	57	50	46	45	75	68	62	55	50	48	76	72	65	62	54	54				
	800	71	62	54	48	43	41	74	67	59	52	48	47	75	69	62	55	50	49	78	74	67	62	56	55				
1000	75	67	59	53	47	46	78	70	62	56	51	50	79	72	64	58	53	52	81	76	70	63	59	58					
1006 1011 1018	600	60	53	46	40	35	32	64	59	52	46	41	40	66	61	55	49	44	42	70	68	64	59	51	50				
	800	62	55	48	41	36	34	68	62	54	49	43	41	69	64	57	52	46	44	73	70	65	60	53	52				
	1000	66	59	51	46	40	37	70	64	57	51	46	44	72	66	59	54	48	46	76	72	66	61	55	53				
	1100	68	60	53	48	41	38	70	65	57	52	46	44	74	68	61	55	50	48	77	73	67	62	56	54				
	1200	69	61	54	49	42	40	71	66	58	53	47	45	75	68	61	56	50	48	78	74	68	63	57	55				
	1400	72	64	57	52	45	43	74	68	61	55	49	47	76	70	63	57	51	50	81	76	69	64	58	57				
1600	75	67	60	55	47	46	77	70	63	57	51	49	78	72	65	59	53	51	82	77	71	65	60	58					
1211 1218 1221	800	63	54	49	41	37	33	67	60	55	49	46	43	68	62	58	52	48	46	73	68	66	61	55	54				
	1100	66	57	52	45	42	38	71	63	58	52	48	45	72	65	61	54	50	48	77	71	68	62	57	56				
	1400	68	59	53	47	44	41	74	66	60	54	50	48	75	68	62	56	52	50	80	74	69	64	59	58				
	1600	70	61	55	49	45	43	75	67	61	55	51	49	75	71	65	61	60	55	83	76	71	66	61	59				
	1700	71	62	56	50	46	44	76	68	62	56	52	50	78	71	65	61	60	55	85	77	72	67	62	60				
	2000	74	64	60	53	49	47	79	69	63	57	53	51	81	72	66	61	60	55	87	80	74	68	64	61				
2300	76	66	62	55	51	49	81	71	65	60	55	54	83	74	68	62	61	56	90	82	76	70	66	63					
1411 1418 1421 1424	1100	64	55	49	40	35	30	69	62	55	49	46	42	71	64	57	52	48	45	76	69	64	59	56	53				
	1500	66	57	51	45	41	36	73	64	57	52	48	45	75	66	60	55	51	48	80	74	68	63	59	56				
	1900	68	59	53	48	43	39	76	66	59	53	49	46	78	69	62	56	52	49	83	77	71	65	61	58				
	2100	70	60	54	50	44	40	77	67	60	54	50	47	81	71	65	58	54	51	85	78	72	66	62	58				
	2300	71	62	56	52	46	42	78	68	61	55	51	48	81	72	65	59	54	51	87	79	72	66	62	59				
	2700	74	64	59	57	50	46	79	70	63	58	53	50	82	73	66	60	56	52	91	81	74	68	63	60				
3100	77	67	61	58	53	49	81	71	64	62	55	52	84	74	67	64	57	54	94	83	75	69	64	61					
1621 1624	1600	66	56	51	46	43	40	70	63	57	53	50	47	72	65	60	56	53	50	78	71	67	64	61	58				
	2100	70	59	54	48	45	42	75	65	60	55	52	49	76	67	62	58	55	52	81	74	70	66	63	60				
	2600	74	62	55	50	48	45	79	68	62	57	54	52	80	70	64	60	57	54	85	77	72	67	65	62				
	2800	75	63	56	51	49	46	81	69	63	57	55	53	83	74	72	70	63	59	87	78	73	71	66	63				
	3100	76	64	57	53	50	48	83	71	64	58	56	54	84	74	72	70	63	59	89	80	74	71	67	64				
	3600	77	65	59	56	52	50	86	73	65	60	57	56	88	75	72	71	64	59	92	82	76	72	68	66				
4100	78	67	62	58	55	53	87	74	67	62	59	57	90	77	73	71	64	60	97	84	77	72	69	67					

NOTES:

- Data obtained from tests conducted in accordance with AHRI Standard 880.
- Sound levels are expressed in decibels, dB re: 1 x 10⁻¹² Watts.
- ΔPs is the difference in static pressure across the primary air valve.
- Duct end corrections included in sound power levels per AHRI Standard 880.
- Certified AHRI data is highlighted blue. Application data (not highlighted blue) is outside the scope of the certification program.

A web-based Computer Selection Program, "Web-Select", is available to facilitate the selection process. Contact your representative to obtain access to this powerful and time-saving program.

SOUND POWER DATA, 50 Hz PSC MOTOR

UNIT FAN ONLY

UNIT SIZE	CFM	RADIATED SOUND POWER DATA						DISCHARGE SOUND POWER DATA							
		OCTAVE BAND NUMBER							OCTAVE BAND NUMBER						
		2	3	4	5	6	7	2	3	4	5	6	7		
0606	300	62	54	52	47	43	40	61	55	50	42	38	37		
	400	69	62	56	52	50	49	65	59	53	48	44	43		
	500	71	65	58	56	53	52	70	64	57	53	49	49		
	510	72	67	60	58	55	55	70	64	58	54	50	50		
0806	300	62	54	52	47	43	40	59	54	49	41	38	37		
	400	69	62	56	52	50	49	63	58	52	47	44	43		
	500	71	65	58	56	53	52	68	63	56	52	49	49		
	520	73	67	61	58	56	55	71	65	60	57	53	53		
1006	300	62	54	52	47	43	40	57	53	49	41	38	37		
	400	69	62	56	52	50	49	61	57	52	47	44	43		
	500	71	65	58	56	53	52	66	62	56	52	49	49		
	540	73	67	61	58	56	55	69	64	59	56	53	53		
0811	400	64	57	50	48	45	38	62	54	51	44	41	37		
	700	68	61	58	54	50	48	67	59	58	55	50	45		
	970	70	66	63	62	57	57	73	66	64	63	57	56		
	1000	73	66	63	62	57	57	73	66	64	64	58	56		
1011	400	64	57	50	48	45	38	60	53	51	44	41	37		
	700	68	61	58	54	50	48	65	58	58	55	50	45		
	1000	73	66	63	62	57	57	70	65	64	64	58	56		
	1100	76	68	63	62	59	59	73	65	64	65	59	57		

NOTES:

- Data obtained from tests conducted in accordance with AHRI Standard 880.
- Sound levels are expressed in decibels, dB re: 1×10^{-12} Watts.
- Fan external static pressure is 0.25 inches w.g.
- Duct end corrections included in sound power levels per AHRI Standard 880.
- Certified AHRI data is highlighted blue. Application data (not highlighted blue) is outside the scope of the certification program.

A web-based Computer Selection Program, "Web-Select", is available to facilitate the selection process. Contact your representative to obtain access to this powerful and time-saving program.

SOUND POWER DATA, 50 Hz PSC MOTOR

UNIT FAN ONLY

UNIT SIZE	CFM	RADIATED SOUND POWER DATA						DISCHARGE SOUND POWER DATA					
		OCTAVE BAND NUMBER						OCTAVE BAND NUMBER					
		2	3	4	5	6	7	2	3	4	5	6	7
1211	400	64	57	50	48	45	38	60	52	51	44	41	37
	700	68	61	58	54	50	48	65	57	58	55	50	45
	1000	73	66	63	62	57	57	70	64	64	64	58	56
	1125	76	68	63	62	59	59	73	67	65	65	61	60
1411	400	64	57	50	48	45	38	58	52	50	44	41	37
	700	68	61	58	54	50	48	63	57	57	55	50	45
	1000	73	66	63	62	57	57	68	64	63	64	58	56
	1075	76	68	63	62	59	59	71	64	65	65	59	57
1018	800	65	58	58	53	47	45	64	56	55	51	45	44
	1100	68	61	60	57	52	51	67	59	57	54	49	49
	1400	71	65	62	61	57	56	71	63	61	59	55	56
	1800	75	70	67	65	62	62	77	71	67	68	63	64
1218	800	65	58	58	53	47	45	64	55	55	51	45	44
	1100	68	61	60	57	52	51	67	58	57	54	49	49
	1400	71	65	62	61	57	56	71	62	61	59	55	56
	1800	75	70	67	65	62	62	76	70	67	68	63	64
	1850	76	70	67	66	63	63	76	71	67	68	63	64
1418	800	65	58	58	53	47	45	62	55	54	51	45	44
	1100	68	61	60	57	52	51	65	58	56	54	49	49
	1400	71	65	62	61	57	56	69	62	60	59	55	56
	1800	75	70	67	65	62	62	74	70	66	68	63	64
	1900	76	70	67	66	63	63	76	70	67	68	63	64
1221	1200	67	63	59	55	53	51	69	59	58	55	49	49
	1600	72	67	63	61	59	58	74	64	63	61	56	56
	1950	75	70	67	65	63	62	77	70	67	67	63	64
	2000	75	70	67	66	64	63	77	70	68	68	63	64
1421	1200	67	63	59	55	53	51	67	59	57	55	49	49
	1600	72	67	63	61	59	58	72	64	62	61	56	56
	2000	75	70	67	66	64	63	75	69	67	68	63	64
	2050	76	71	68	67	65	64	77	69	69	69	63	64
1621	1200	67	63	59	55	53	51	67	58	57	55	49	49
	1600	72	67	63	61	59	58	72	63	62	61	56	56
	2000	75	70	67	66	64	63	75	68	67	68	63	64
	2050	76	71	68	67	65	64	78	71	69	69	65	64
1424	1500	68	64	58	57	55	53	69	62	60	57	53	52
	1900	72	68	63	62	60	59	72	65	65	63	60	59
	2400	76	72	68	67	65	63	77	70	70	70	66	66
1624	1500	68	64	58	57	55	53	69	61	60	57	53	52
	1900	72	68	63	62	60	59	72	64	65	63	60	59
	2400	76	72	68	67	65	63	76	70	70	70	66	66

NOTES:

- Data obtained from tests conducted in accordance with AHRI Standard 880.
- Sound levels are expressed in decibels, dB re: 1 x 10⁻¹² Watts.
- Fan external static pressure is 0.25 inches w.g.
- Duct end corrections included in sound power levels per AHRI Standard 880.
- Certified AHRI data is highlighted blue. Application data (not highlighted blue) is outside the scope of the certification program.

A web-based Computer Selection Program, "Web-Select", is available to facilitate the selection process. Contact your representative to obtain access to this powerful and time-saving program.

FAN PERFORMANCE DATA, 50 HZ PSC MOTOR

GENERAL FAN NOTE

Each fan curve depicts the actual performance for the relative motor tap without any additional fan balance adjustment. Actual specified capacities which fall below a particular fan curve (LOW, MED or HI) can be obtained by adjustment of the electronic fan speed controller. Selections should only be made in the area below and/or to the left of each particular fan curve. The minimum external static pressure requirement is shown for each fan assembly. The unit fan should not be energized prior to realizing this minimum external static pressure.

Terminals with electric heat (Model VFR-EH) require a minimum of 0.1" w.g. downstream pressure.

UNIT SIZE 1018, 1218, 1418

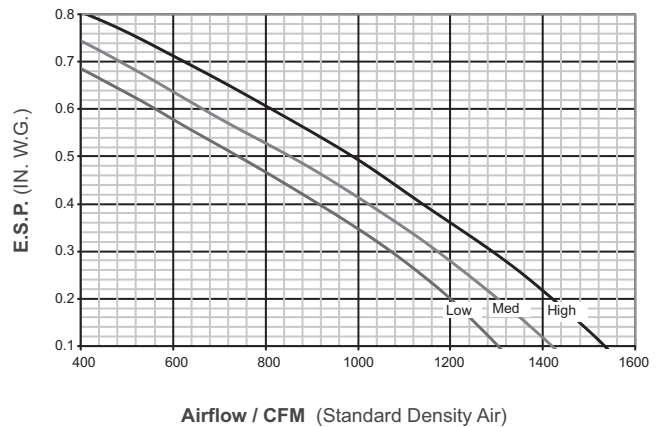

UNIT SIZE 0606, 0806, 1006

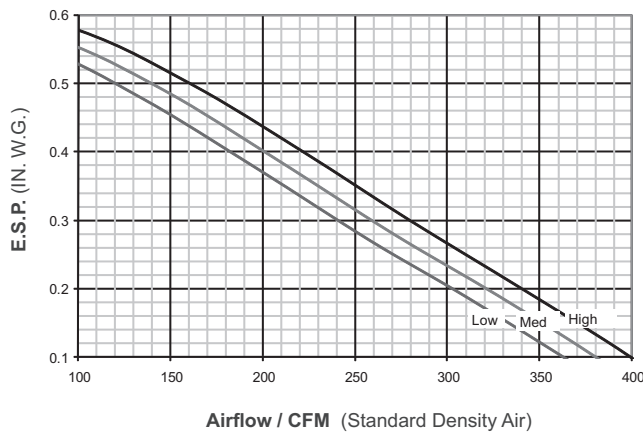

UNIT SIZE 1221, 1421, 1621

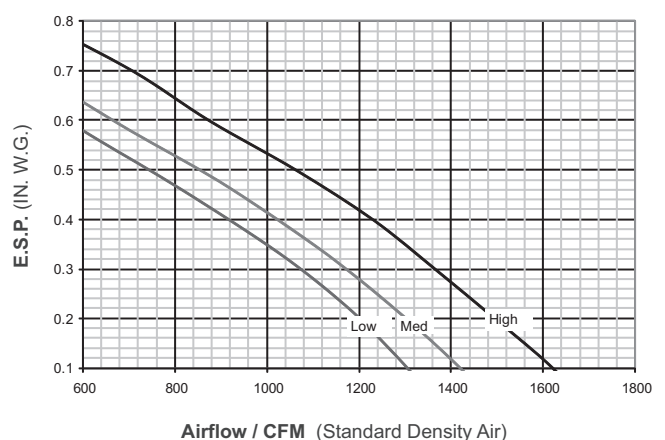

UNIT SIZE 0811, 1011, 1211

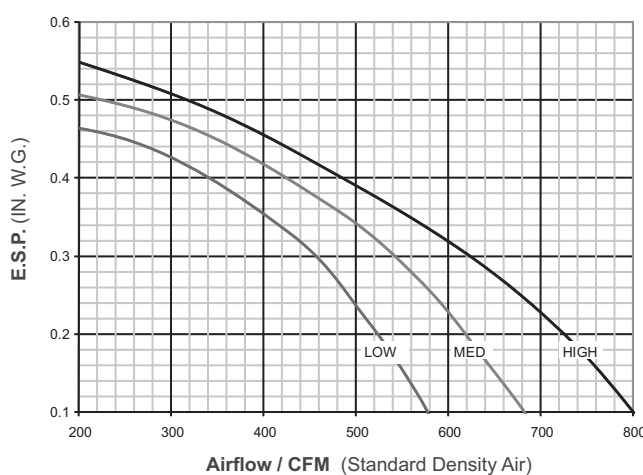

UNIT SIZE 1424, 1624

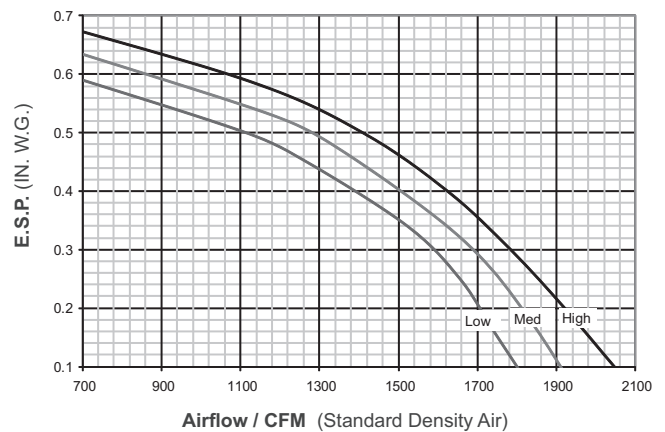

GENERAL SELECTION DATA, 60 HZ PSC MOTOR

PRIMARY AIR VALVE

UNIT SIZE	CFM	MIN. DPs (IN. W.G.)	ROOM NOISE CRITERIA (NC)					
			0.5" W.G. DPs		1.0" W.G. DPs		3.0" W.G. DPs	
			Dis.	Rad.	Dis.	Rad.	Dis.	Rad.
0404	100	.01	--	--	--	--	--	--
	150	.01	--	--	21	--	26	23
	200	.02	20	--	25	23	31	29
	250	.02	24	23	29	27	36	34
0504	100	.01	--	--	--	--	--	--
	200	.01	--	--	--	--	21	22
	300	.02	20	--	21	22	28	28
	350	.02	21	20	22	24	29	30
0604 0606	200	.03	--	--	--	--	--	22
	250	.04	--	--	--	--	22	24
	300	.06	--	--	--	--	22	25
	350	.08	--	--	20	20	25	28
	450	.14	23	22	26	25	30	32
0804 0806 0811	550	.21	28	29	32	29	35	34
	300	.01	--	--	--	--	--	29
	400	.03	--	--	--	20	24	32
	500	.04	--	--	21	23	27	33
	600	.06	--	22	23	25	31	35
1006 1011 1018	800	.10	23	27	27	30	34	38
	1000	.15	28	32	32	35	36	40
	600	.01	--	--	--	24	27	32
	800	.01	--	23	--	27	28	35
	1000	.01	--	25	22	29	31	37
1211 1218 1221	1200	.02	20	29	23	32	33	40
	1400	.02	24	33	27	33	36	42
	1600	.03	28	34	30	35	37	44
	800	.01	--	20	--	24	27	34
	1100	.02	--	24	22	28	30	37
1411 1418 1421 1424	1400	.04	--	28	26	32	34	40
	1700	.06	22	32	29	34	40	45
	2000	.08	26	35	32	38	42	48
	2300	.10	29	37	35	40	46	50
	1100	.02	--	--	20	23	29	33
1621 1624	1500	.04	--	22	25	28	34	40
	1900	.06	--	24	29	33	38	44
	2300	.08	23	28	32	37	43	47
	2700	.12	27	30	33	38	48	50
	3100	.15	30	33	35	42	52	52
1621 1624	1600	.01	--	24	21	33	31	42
	2100	.02	21	28	28	37	35	47
	2600	.03	26	30	33	39	40	49
	3100	.04	29	35	38	42	45	50
	3600	.05	30	37	41	43	49	54
4100	.07	31	38	43	45	56	57	

See notes on following page.

FAN

UNIT SIZE	CFM	ROOM NOISE CRITERIA (NC)	
		Discharge	Radiated
		0404	200
300	--		32
400	--		38
450	--		38
0504	200	--	26
	300	--	32
	400	--	38
	450	--	38
0604	200	--	26
	300	--	32
	400	--	38
	450	--	38
0804	200	--	26
	300	--	32
	400	--	38
	450	--	38
0606	300	--	27
	400	--	34
	500	24	37
0806	300	--	27
	400	--	34
	500	21	37
1006	300	--	27
	400	--	34
	500	20	37
0811	400	--	29
	700	--	33
	1000	25	39
1011	400	--	29
	700	--	33
	1000	23	39
1211	400	--	29
	700	--	33
	1000	21	39
1411	400	--	29
	700	--	33
	1000	21	39
1018	800	--	33
	1100	--	35
	1400	23	37
	1800	30	43
1218	800	--	33
	1100	--	35
	1400	23	37
	1800	29	43
1418	800	--	33
	1100	--	35
	1400	20	37
	1800	29	43
1221	1200	20	34
	1600	26	38
	2000	30	43
1421	1200	--	34
	1600	24	38
	2000	28	43
1621	1200	--	34
	1600	24	38
	2000	28	43
1424	1500	20	35
	1900	24	39
	2400	30	44
1624	1500	20	35
	1900	24	39
	2400	29	44

GENERAL SELECTION DATA, 60 HZ PSC MOTOR

DISCHARGE ATTENUATION VALUES	OCTAVE BAND					
	2	3	4	5	6	7
Small Box (< 300 CFM)	24	28	39	53	59	40
Medium Box (300-700 CFM)	27	29	40	51	53	39
Large Box (> 700 CFM)	29	30	41	51	52	39

RADIATED ATTENUATION VALUES	OCTAVE BAND					
	2	3	4	5	6	7
Type 2 - Mineral Fiber Ceiling	18	19	20	26	31	36

NOTES:

- Min. ΔP_s is the static pressure difference between the terminal inlet and discharge with the damper wide open. Terminals equipped with electric heat (Model VFR-EH) require the addition of the heater pressure drop (see page 22) to determine the cumulative minimum ΔP_s for the unit.
- Performance data obtained from tests conducted in accordance with AHRI Standard 880.
- Dash (-) indicates NC level less than 20.
- NC values are calculated using attenuation values provided in appendix E of AHRI 885-2008, as shown on the left.
- NC (sound pressure) levels predicted by subtracting appropriate values shown at left from published sound power levels (following pages).

HORSEPOWER / AMPERAGE DATA

UNIT SIZE	FAN HORSEPOWER			AMPERAGE								
				115V			208V			277V		
	LOW	MED	HI	LOW	MED	HI	LOW	MED	HI	LOW	MED	HI
0404, 0504, 0604, 0804	1/60	1/25	1/12	0.5	0.8	1.1	0.3	0.4	0.6	0.37	0.45	0.5
0606, 0806, 1006	1/10	1/8	1/6	2.2	2.4	2.7	0.55	0.9	1.4	0.8	0.9	1.0
0811, 1011, 1211, 1411	1/8	1/6	1/4	3.7	4.1	4.9	1.1	1.5	2.2	1.4	1.7	2.0
1018, 1218, 1418	1/4	1/3	1/2	8.8	9.3	9.6	2.3	2.7	4.0	2.8	2.9	3.6
1221, 1421, 1621	1/3	1/2	3/4	9.4	10.3	10.5	2.5	3.2	4.2	3.6	3.7	4.3
1424, 1624	1/2	3/4	1	8.9	11.0	12.3	1.8	2.8	5.3	3.4	3.8	4.5

A web-based Computer Selection Program, "Web-Select", is available to facilitate the selection process. Contact your representative to obtain access to this powerful and time-saving program.

SOUND POWER DATA, 60 Hz PSC MOTOR

PRIMARY AIR VALVE, RADIATED

UNIT SIZE	CFM	0.5" W.G. DPs							1.0" W.G. DPs							1.5" W.G. DPs							3.0" W.G. DPs																																																																																																																																																												
		OCTAVE BAND NUMBER							OCTAVE BAND NUMBER							OCTAVE BAND NUMBER							OCTAVE BAND NUMBER																																																																																																																																																												
		2	3	4	5	6	7	2	3	4	5	6	7	2	3	4	5	6	7	2	3	4	5	6	7	2	3	4	5	6	7																																																																																																																																																				
0404	100	49	42	36	29	29	29	52	45	39	30	30	29	52	46	40	32	31	30	54	47	44	36	33	33	150	52	45	38	31	29	29	57	49	42	33	31	29	58	50	44	34	32	30	60	53	48	39	35	34	200	57	48	40	33	29	29	60	52	44	35	32	30	61	53	46	36	33	32	65	57	51	41	37	36	250	60	52	44	36	30	30	63	54	47	38	33	31	64	56	48	39	34	32	69	61	53	43	39	37																																																																															
	0504	100	46	39	35	29	26	27	48	41	39	30	27	28	49	42	40	32	29	30	53	44	42	37	34	34	200	51	43	38	30	27	28	54	45	41	33	29	29	55	46	43	35	31	30	59	51	48	40	36	35	300	55	47	42	34	29	29	59	49	45	36	31	30	60	51	46	38	32	32	64	56	51	43	37	36	350	58	50	44	36	30	29	61	52	47	38	33	31	62	53	48	40	34	32	66	57	52	44	38	37																																																																														
		0604 0606	200	47	40	37	32	27	28	51	44	41	35	29	28	52	46	43	36	30	29	57	51	48	41	34	32	250	49	42	39	34	29	28	53	46	43	36	30	28	54	48	45	38	31	29	59	53	50	42	35	32	300	52	45	41	36	30	28	56	47	44	38	31	28	58	49	46	39	32	29	62	55	51	43	36	33	350	55	47	43	37	32	29	57	49	46	39	33	29	59	51	48	40	34	30	64	57	52	44	37	33	400	57	50	44	38	32	29	60	52	48	40	34	30	62	54	50	42	36	31	66	58	54	46	38	34	450	59	52	46	39	33	29	62	54	49	42	36	31	63	56	50	43	37	32	67	60	55	47	40	35	550	65	56	50	42	35	31	65	57	52	43	37	32	66	58	53	44	38	33	69	62	57	48	41	36		
			0804 0806 0811	300	51	43	39	33	28	26	57	50	45	37	31	28	58	52	47	40	33	30	62	57	54	47	38	35	400	53	45	40	35	29	27	58	51	46	39	32	29	60	54	49	41	34	31	65	61	57	48	40	36	500	56	47	42	36	31	28	60	52	47	40	34	30	62	54	50	42	36	32	66	62	58	49	41	37	600	59	49	44	37	33	29	62	53	48	41	36	31	64	56	51	43	39	33	68	64	59	50	43	38	700	61	51	46	38	34	30	64	54	49	42	38	32	66	58	52	45	40	33	70	66	60	50	44	38	800	63	53	47	40	36	30	66	56	50	44	39	32	67	59	52	46	40	34	71	67	60	51	45	39	1000	67	57	51	43	38	32	70	60	54	46	41	34	71	62	56	48	42	36	74	69	61	52	46	41	
1006 1011 1018	600			57	48	41	34	29	27	61	52	46	38	32	29	62	54	48	40	34	30	67	60	56	48	39	35	800	60	51	44	37	31	28	63	54	48	40	33	30	65	56	50	42	35	32	70	62	58	50	41	38	1000	62	52	45	39	33	29	65	56	50	43	37	34	66	58	52	45	38	35	71	64	59	51	43	39	1100	64	54	46	40	34	30	66	57	51	44	38	35	68	60	54	46	40	38	72	64	60	52	44	41	1200	65	55	48	41	35	32	67	58	52	45	39	36	69	60	54	47	41	38	74	65	60	52	46	43	1400	68	58	51	44	38	34	68	60	54	46	40	37	70	62	56	48	42	39	75	67	61	54	47	46	1600	69	60	52	45	39	35	70	62	56	48	42	38	72	64	58	50	44	40	77	68	62	55	49	47		
	1211 1218 1221			800	58	48	42	36	29	27	61	53	47	39	33	30	63	56	50	41	35	32	68	63	57	48	42	39	1100	61	52	46	38	31	28	64	55	49	41	35	31	66	58	52	43	37	33	71	65	59	50	44	40	1400	64	56	48	40	33	29	67	58	52	43	37	33	69	60	54	45	39	35	74	67	61	52	45	41	1600	66	58	51	42	35	30	68	60	53	45	38	34	71	63	60	53	47	37	77	68	62	53	47	42	1700	67	59	52	43	36	31	69	61	54	46	39	35	72	64	60	53	47	37	78	69	63	54	47	43	2000	70	61	54	46	38	33	72	63	57	48	41	36	74	65	61	54	48	38	80	71	64	55	49	45	2300	71	63	56	47	40	35	74	65	59	50	43	38	76	67	61	54	49	40	82	72	66	57	51	47	
				1411 1418 1421 1424	1100	55	46	41	34	28	28	60	52	46	38	31	30	62	54	48	40	33	32	68	62	56	46	40	38	1500	59	49	43	36	30	29	64	55	48	40	33	31	66	58	51	42	35	33	74	66	59	50	42	39	1900	61	52	45	38	32	30	68	57	49	42	35	33	70	60	52	44	38	35	77	68	61	51	45	42	2100	62	53	46	39	33	30	70	58	50	43	36	34	73	61	54	46	40	38	78	68	62	52	46	42	2300	64	54	47	40	34	31	71	59	51	44	38	35	73	62	54	46	40	39	79	69	62	52	46	43	2700	66	56	49	42	36	33	72	61	53	46	40	38	74	63	56	48	42	40	82	70	63	54	48	46	3100	68	58	51	44	38	34	75	62	55	47	42	40	77	64	57	49	44	42	83	71	63	55	49	47
					1621 1624	1600	61	53	47	37	30	28	68	60	53	43	36	32	70	62	55	45	38	34	75	69	62	52	45	42	2100	64	56	49	42	34	31	71	62	55	46	39	35	73	65	58	48	42	38	79	73	66	56	49	45	2600	66	58	51	43	37	33	73	64	56	48	40	36	75	66	59	50	42	38	81	74	67	57	50	46	2800	68	59	52	43	37	33	74	64	57	49	41	36	77	68	61	52	44	40	81	75	67	58	50	46	3100	70	60	53	44	38	34	75	65	58	50	42	37	78	68	61	53	44	40	82	76	68	59	51	47	3600	71	61	54	46	39	35	76	66	59	51	43	39	78	69	62	54	45	41	84	77	69	61	52	48	4100	72	63	57	48	40	36	78	68	60	52	44	40	80	70	62	54	47	43	86	78	70	62	55

NOTES:

- Data obtained from tests conducted in accordance with AHRI Standard 880.
- Sound levels are expressed in decibels, dB re: 1 x 10⁻¹² Watts.
- ΔPs is the difference in static pressure across the primary air valve.
- Certified AHRI data is highlighted blue. Application data (not highlighted blue) is outside the scope of the certification program.

A web-based Computer Selection Program, "Web-Select", is available to facilitate the selection process. Contact your representative to obtain access to this powerful and time-saving program.

SOUND POWER DATA, 60 Hz PSC MOTOR

PRIMARY AIR VALVE, DISCHARGE

UNIT SIZE	CFM	0.5" W.G. DPs							1.0" W.G. DPs							1.5" W.G. DPs							3.0" W.G. DPs								
		OCTAVE BAND NUMBER							OCTAVE BAND NUMBER							OCTAVE BAND NUMBER							OCTAVE BAND NUMBER								
		2	3	4	5	6	7	2	3	4	5	6	7	2	3	4	5	6	7	2	3	4	5	6	7	2	3	4	5	6	7
0404	100	58	54	43	34	28	28	59	57	47	39	32	32	59	57	48	41	34	34	60	58	51	47	42	42						
	150	60	57	46	38	31	31	62	62	51	42	36	36	63	63	52	44	38	38	66	66	57	51	45	45						
	200	63	61	49	41	34	34	66	65	53	45	39	39	67	66	55	47	41	41	71	70	60	53	47	47						
	250	67	64	52	45	37	37	70	68	56	48	41	41	71	69	58	50	43	43	75	74	63	55	49	49						
0504	100	53	48	43	34	29	29	54	50	46	40	34	34	55	51	47	42	36	36	58	52	49	48	44	44						
	200	57	51	45	38	32	32	60	56	49	42	37	37	61	57	51	45	40	40	65	61	56	53	47	47						
	300	64	58	50	43	36	35	65	61	53	46	40	40	66	63	55	48	42	42	71	67	60	55	48	48						
	350	66	60	53	46	39	38	68	63	55	49	42	42	69	65	57	51	44	44	73	69	62	57	50	50						
0604 0606	200	57	49	43	34	30	29	59	54	47	40	34	34	60	55	49	43	36	36	63	59	54	51	44	44						
	250	59	52	44	36	31	30	61	56	48	41	34	34	62	57	50	44	36	36	66	62	56	52	44	44						
	300	62	54	46	38	31	30	64	58	50	42	35	35	65	59	52	45	38	38	68	64	57	52	45	45						
	350	65	56	48	39	34	33	67	61	52	44	37	37	68	62	54	46	39	39	71	66	60	53	45	45						
	400	68	59	50	41	36	35	70	63	54	45	39	38	71	65	56	48	42	42	73	68	62	54	46	46						
	450	70	61	53	44	38	37	72	64	56	47	41	40	73	65	58	49	42	42	75	70	63	55	47	47						
	550	74	64	56	48	41	40	77	69	60	51	45	44	78	70	62	53	46	46	79	73	66	58	50	50						
0804 0806 0811	300	57	50	44	38	33	31	61	56	49	44	38	37	62	57	51	48	41	40	66	61	59	58	49	48						
	400	60	53	47	41	36	32	65	58	51	46	41	40	66	60	54	49	43	42	70	65	62	59	50	50						
	500	63	55	49	43	38	35	67	60	53	47	43	41	68	62	55	50	45	44	72	67	63	60	51	51						
	600	66	58	51	45	40	38	69	63	56	49	45	43	70	65	58	52	47	45	75	70	64	61	53	52						
	700	68	60	53	46	42	40	72	65	57	50	46	45	75	68	62	55	50	48	76	72	65	62	54	54						
	800	71	62	54	48	43	41	74	67	59	52	48	47	75	69	62	55	50	49	78	74	67	62	56	55						
1000	75	67	59	53	47	46	78	70	62	56	51	50	79	72	64	58	53	52	81	76	70	63	59	58							
1006 1011 1018	600	60	53	46	40	35	32	64	59	52	46	41	40	66	61	55	49	44	42	70	68	64	59	51	50						
	800	62	55	48	41	36	34	68	62	54	49	43	41	69	64	57	52	46	44	73	70	65	60	53	52						
	1000	66	59	51	46	40	37	70	64	57	51	46	44	72	66	59	54	48	46	76	72	66	61	55	53						
	1100	68	60	53	48	41	38	70	65	57	52	46	44	74	68	61	55	50	48	77	73	67	62	56	54						
	1200	69	61	54	49	42	40	71	66	58	53	47	45	75	68	61	56	50	48	78	74	68	63	57	55						
	1400	72	64	57	52	45	43	74	68	61	55	49	47	76	70	63	57	51	50	81	76	69	64	58	57						
1600	75	67	60	55	47	46	77	70	63	57	51	49	78	72	65	59	53	51	82	77	71	65	60	58							
1211 1218 1221	800	63	54	49	41	37	33	67	60	55	49	46	43	68	62	58	52	48	46	73	68	66	61	55	54						
	1100	66	57	52	45	42	38	71	63	58	52	48	45	72	65	61	54	50	48	77	71	68	62	57	56						
	1400	68	59	53	47	44	41	74	66	60	54	50	48	75	68	62	56	52	50	80	74	69	64	59	58						
	1600	70	61	55	49	45	43	75	67	61	55	51	49	75	71	65	61	60	55	83	76	71	66	61	59						
	1700	71	62	56	50	46	44	76	68	62	56	52	50	78	71	65	61	60	55	85	77	72	67	62	60						
	2000	74	64	60	53	49	47	79	69	63	57	53	51	81	72	66	61	60	55	87	80	74	68	64	61						
2300	76	66	62	55	51	49	81	71	65	60	55	54	83	74	68	62	61	56	90	82	76	70	66	63							
1411 1418 1421 1424	1100	64	55	49	40	35	30	69	62	55	49	46	42	71	64	57	52	48	45	76	69	64	59	56	53						
	1500	66	57	51	45	41	36	73	64	57	52	48	45	75	66	60	55	51	48	80	74	68	63	59	56						
	1900	68	59	53	48	43	39	76	66	59	53	49	46	78	69	62	56	52	49	83	77	71	65	61	58						
	2100	70	60	54	50	44	40	77	67	60	54	50	47	81	71	65	58	54	51	85	78	72	66	62	58						
	2300	71	62	56	52	46	42	78	68	61	55	51	48	81	72	65	59	54	51	87	79	72	66	62	59						
	2700	74	64	59	57	50	46	79	70	63	58	53	50	82	73	66	60	56	52	91	81	74	68	63	60						
3100	77	67	61	58	53	49	81	71	64	62	55	52	84	74	67	64	57	54	94	83	75	69	64	61							
1621 1624	1600	66	56	51	46	43	40	70	63	57	53	50	47	72	65	60	56	53	50	78	71	67	64	61	58						
	2100	70	59	54	48	45	42	75	65	60	55	52	49	76	67	62	58	55	52	81	74	70	66	63	60						
	2600	74	62	55	50	48	45	79	68	62	57	54	52	80	70	64	60	57	54	85	77	72	67	65	62						
	2800	75	63	56	51	49	46	81	69	63	57	55	53	83	74	72	70	63	59	87	78	73	71	66	63						
	3100	76	64	57	53	50	48	83	71	64	58	56	54	84	74	72	70	63	59	89	80	74	71	67	64						
	3600	77	65	59	56	52	50	86	73	65	60	57	56	88	75	72	71	64	59	92	82	76	72	68	66						
4100	78	67	62	58	55	53	87	74	67	62	59	57	90	77	73	71	64	60	97	84	77	72	69	67							

NOTES:

- Data obtained from tests conducted in accordance with AHRI Standard 880.
- Sound levels are expressed in decibels, dB re: 1 x 10⁻¹² Watts.
- ΔPs is the difference in static pressure across the primary air valve.
- Duct end corrections included in sound power levels per AHRI Standard 880.
- Certified AHRI data is highlighted blue. Application data (not highlighted blue) is outside the scope of the certification program.

A web-based Computer Selection Program, "Web-Select", is available to facilitate the selection process. Contact your representative to obtain access to this powerful and time-saving program.

SOUND POWER DATA, 60 Hz PSC MOTOR

UNIT FAN ONLY

UNIT SIZE	CFM	RADIATED SOUND POWER DATA						DISCHARGE SOUND POWER DATA					
		OCTAVE BAND NUMBER						OCTAVE BAND NUMBER					
		2	3	4	5	6	7	2	3	4	5	6	7
0404	200	63	57	52	50	44	39	63	53	49	41	36	31
	300	66	62	57	52	46	44	64	57	50	46	40	36
	400	67	67	57	52	46	45	64	58	51	51	44	40
	450	68	67	58	54	48	46	66	60	54	53	46	43
0504	200	63	57	52	50	44	39	63	53	49	41	36	31
	300	66	62	57	52	46	44	64	57	50	46	40	36
	400	67	67	57	52	46	45	64	58	51	51	44	40
	450	68	67	58	54	48	46	66	60	54	53	46	43
0604	200	63	57	52	50	44	39	63	53	49	41	36	31
	300	66	62	57	52	46	44	64	57	50	46	40	36
	380	67	67	57	52	46	45	64	58	51	47	40	37
	400	67	67	57	52	46	45	64	58	51	51	44	40
	450	68	67	58	54	48	46	66	60	54	53	46	43
0804	200	63	57	52	50	44	39	61	52	48	40	36	31
	300	66	62	57	52	46	44	62	56	49	45	40	36
	400	67	67	57	52	46	45	62	57	50	50	44	40
	410	67	67	57	52	46	45	63	57	51	54	47	44
	450	68	67	58	54	48	46	64	59	53	54	47	44
0606	300	62	54	52	47	43	40	61	55	50	42	38	37
	400	69	62	56	52	50	49	65	59	53	48	44	43
	500	71	65	58	56	53	52	70	64	57	53	49	49
	510	72	67	60	58	55	55	70	64	58	54	50	50
0806	300	62	54	52	47	43	40	59	54	49	41	38	37
	400	69	62	56	52	50	49	63	58	52	47	44	43
	500	71	65	58	56	53	52	68	63	56	52	49	49
	520	73	67	61	58	56	55	71	65	60	57	53	53
1006	300	62	54	52	47	43	40	57	53	49	41	38	37
	400	69	62	56	52	50	49	61	57	52	47	44	43
	500	71	65	58	56	53	52	66	62	56	52	49	49
	540	73	67	61	58	56	55	69	64	59	56	53	53
0811	400	64	57	50	48	45	38	62	54	51	44	41	37
	700	68	61	58	54	50	48	67	59	58	55	50	45
	970	70	66	63	62	57	57	73	66	64	63	57	56
	1000	73	66	63	62	57	57	73	66	64	64	58	56
1011	400	64	57	50	48	45	38	60	53	51	44	41	37
	700	68	61	58	54	50	48	65	58	58	55	50	45
	1000	73	66	63	62	57	57	70	65	64	64	58	56
	1100	76	68	63	62	59	59	73	65	64	65	59	57

NOTES:

- Data obtained from tests conducted in accordance with AHRI Standard 880.
- Sound levels are expressed in decibels, dB re: 1 x 10⁻¹² Watts.
- Fan external static pressure is 0.25 inches w.g.
- Duct end corrections included in sound power levels per AHRI Standard 880.
- Certified AHRI data is highlighted blue. Application data (not highlighted blue) is outside the scope of the certification program.

A web-based Computer Selection Program, "Web-Select", is available to facilitate the selection process. Contact your representative to obtain access to this powerful and time-saving program.

SOUND POWER DATA, 60 Hz PSC MOTOR

UNIT FAN ONLY

UNIT SIZE	CFM	RADIATED SOUND POWER DATA						DISCHARGE SOUND POWER DATA					
		OCTAVE BAND NUMBER						OCTAVE BAND NUMBER					
		2	3	4	5	6	7	2	3	4	5	6	7
1211	400	64	57	50	48	45	38	60	52	51	44	41	37
	700	68	61	58	54	50	48	65	57	58	55	50	45
	1000	73	66	63	62	57	57	70	64	64	64	58	56
	1125	76	68	63	62	59	59	73	67	65	65	61	60
1411	400	64	57	50	48	45	38	58	52	50	44	41	37
	700	68	61	58	54	50	48	63	57	57	55	50	45
	1000	73	66	63	62	57	57	68	64	63	64	58	56
	1075	76	68	63	62	59	59	71	64	65	65	59	57
1018	800	65	58	58	53	47	45	64	56	55	51	45	44
	1100	68	61	60	57	52	51	67	59	57	54	49	49
	1400	71	65	62	61	57	56	71	63	61	59	55	56
	1800	75	70	67	65	62	62	77	71	67	68	63	64
1218	800	65	58	58	53	47	45	64	55	55	51	45	44
	1100	68	61	60	57	52	51	67	58	57	54	49	49
	1400	71	65	62	61	57	56	71	62	61	59	55	56
	1800	75	70	67	65	62	62	76	70	67	68	63	64
	1850	76	70	67	66	63	63	76	71	67	68	63	64
1418	800	65	58	58	53	47	45	62	55	54	51	45	44
	1100	68	61	60	57	52	51	65	58	56	54	49	49
	1400	71	65	62	61	57	56	69	62	60	59	55	56
	1800	75	70	67	65	62	62	74	70	66	68	63	64
	1900	76	70	67	66	63	63	76	70	67	68	63	64
1221	1200	67	63	59	55	53	51	69	59	58	55	49	49
	1600	72	67	63	61	59	58	74	64	63	61	56	56
	1950	75	70	67	65	63	62	77	70	67	67	63	64
	2000	75	70	67	66	64	63	77	70	68	68	63	64
1421	1200	67	63	59	55	53	51	67	59	57	55	49	49
	1600	72	67	63	61	59	58	72	64	62	61	56	56
	2000	75	70	67	66	64	63	75	69	67	68	63	64
	2050	76	71	68	67	65	64	77	69	69	69	63	64
1621	1200	67	63	59	55	53	51	67	58	57	55	49	49
	1600	72	67	63	61	59	58	72	63	62	61	56	56
	2000	75	70	67	66	64	63	75	68	67	68	63	64
	2050	76	71	68	67	65	64	78	71	69	69	65	64
1424	1500	68	64	58	57	55	53	69	62	60	57	53	52
	1900	72	68	63	62	60	59	72	65	65	63	60	59
	2400	76	72	68	67	65	63	77	70	70	70	66	66
1624	1500	68	64	58	57	55	53	69	61	60	57	53	52
	1900	72	68	63	62	60	59	72	64	65	63	60	59
	2400	76	72	68	67	65	63	76	70	70	70	66	66

NOTES:

- Data obtained from tests conducted in accordance with AHRI Standard 880.
- Sound levels are expressed in decibels, dB re: 1 x 10⁻¹² Watts.
- Fan external static pressure is 0.25 inches w.g.
- Duct end corrections included in sound power levels per AHRI Standard 880.
- Certified AHRI data is highlighted blue. Application data (not highlighted blue) is outside the scope of the certification program.

A web-based Computer Selection Program, "Web-Select", is available to facilitate the selection process. Contact your representative to obtain access to this powerful and time-saving program.

FAN PERFORMANCE DATA, 60 HZ PSC MOTOR

GENERAL FAN NOTE

Each fan curve depicts the actual performance for the relative motor tap without any additional fan balance adjustment. Actual specified capacities which fall below a particular fan curve (LOW, MED or HI) can be obtained by adjustment of the electronic fan speed controller. Selections should only be made in the non-shaded areas. The minimum external static pressure requirement is shown for each fan assembly. The unit fan should not be energized prior to realizing this minimum external static pressure.

Terminals with electric heat (Model VFR-EH) require a minimum of 0.1" w.g. downstream pressure.

UNIT SIZES 0404, 0504, 0604, 0804

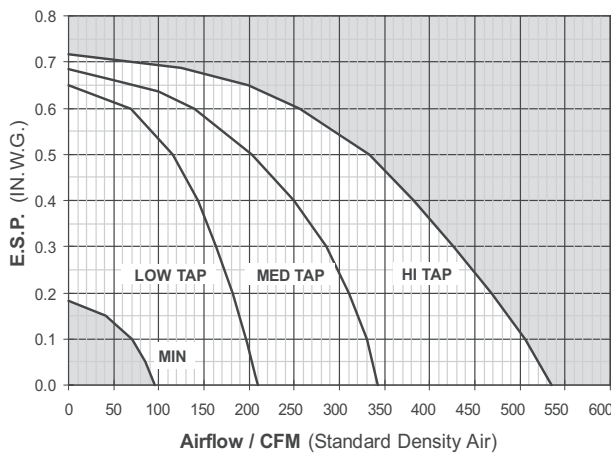

UNIT SIZE 0606

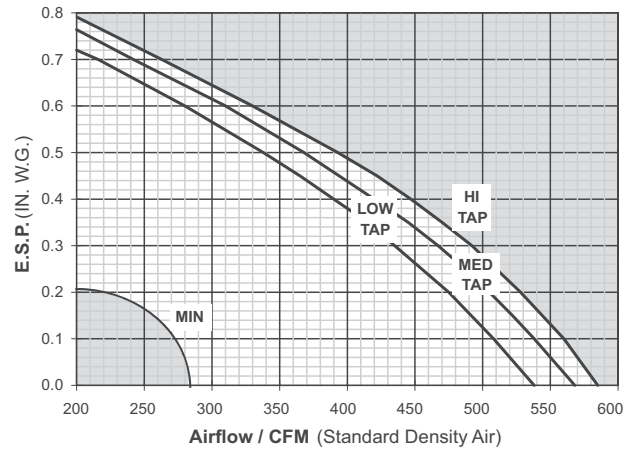

UNIT SIZE 0806

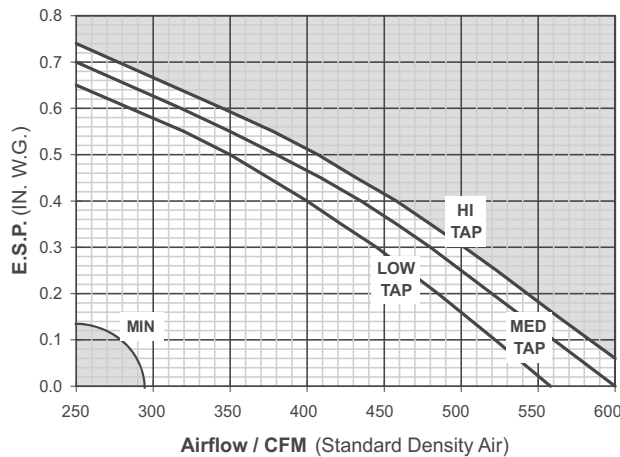

UNIT SIZE 0811

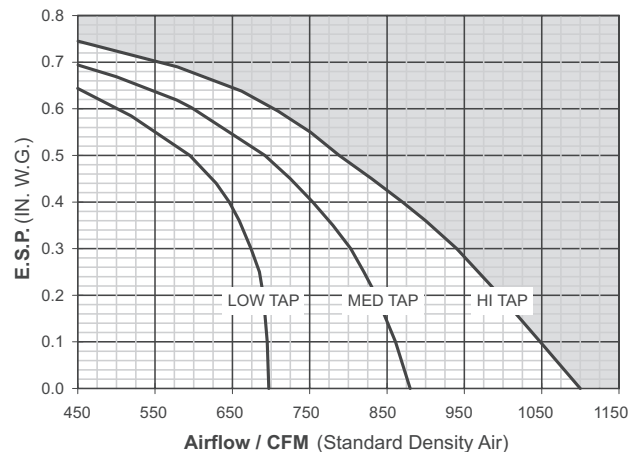

FAN PERFORMANCE DATA, 60 Hz PSC MOTOR

UNIT SIZE 1006

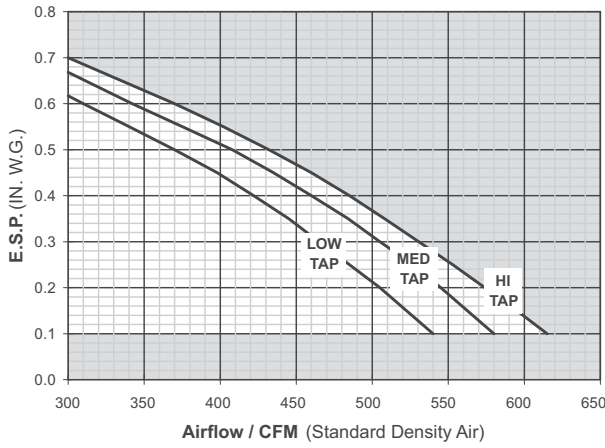

UNIT SIZE 1011

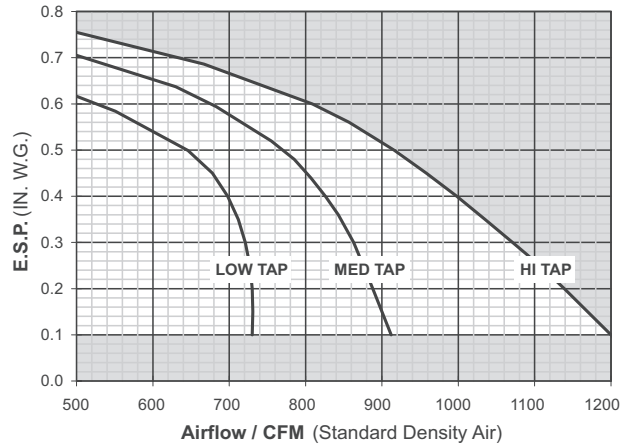

UNIT SIZE 1018

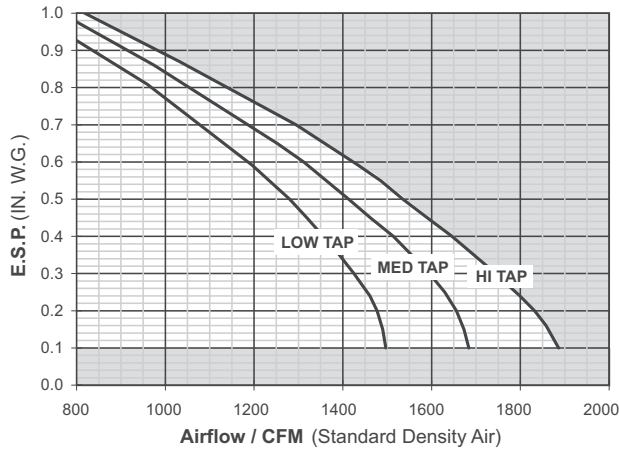

UNIT SIZE 1211

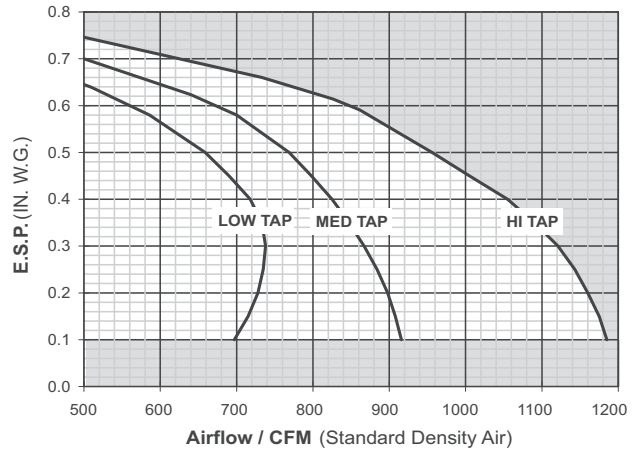

UNIT SIZE 1218

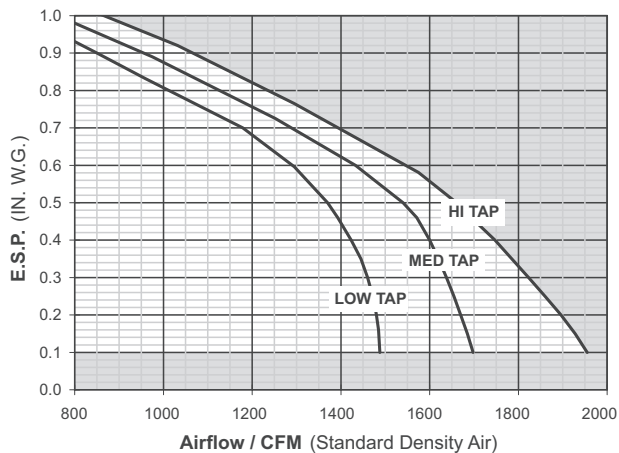

UNIT SIZE 1221

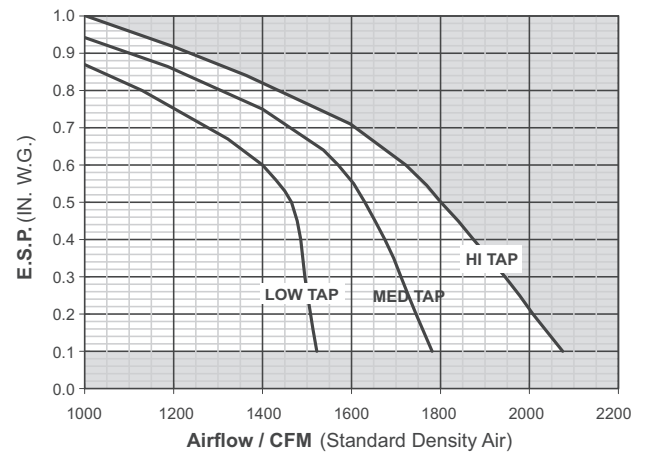

FAN PERFORMANCE DATA, 60 Hz PSC MOTOR

UNIT SIZE 1411

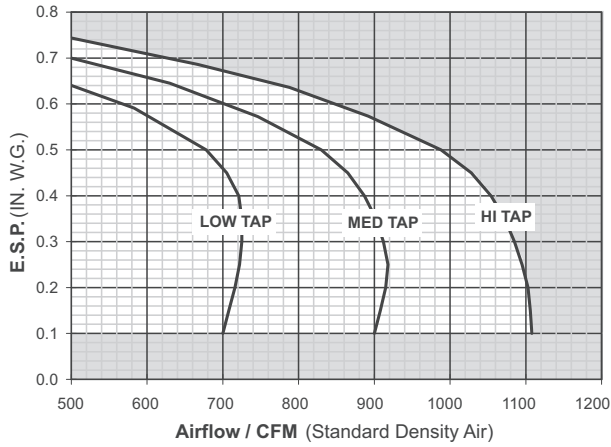

UNIT SIZE 1418

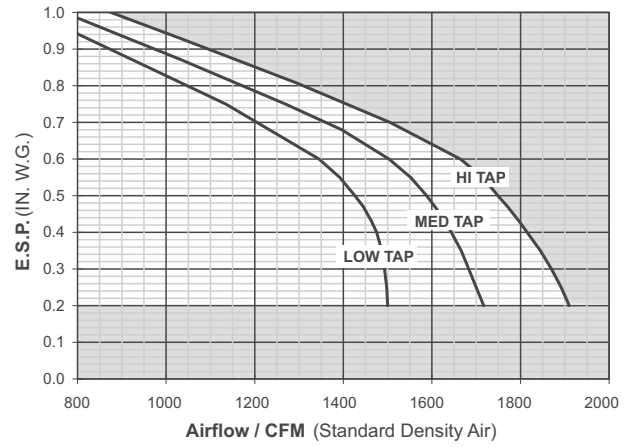

UNIT SIZE 1421

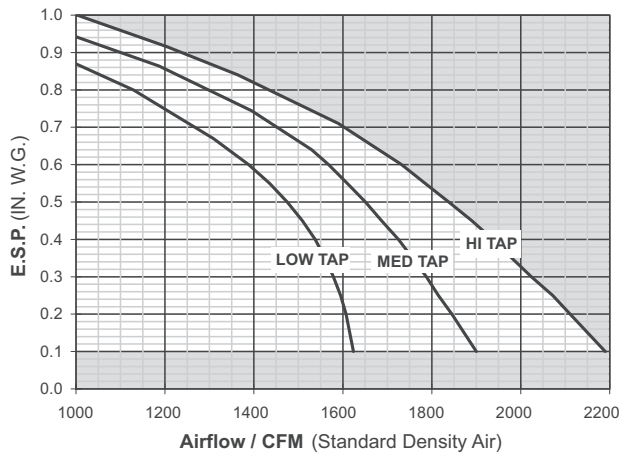

UNIT SIZE 1424

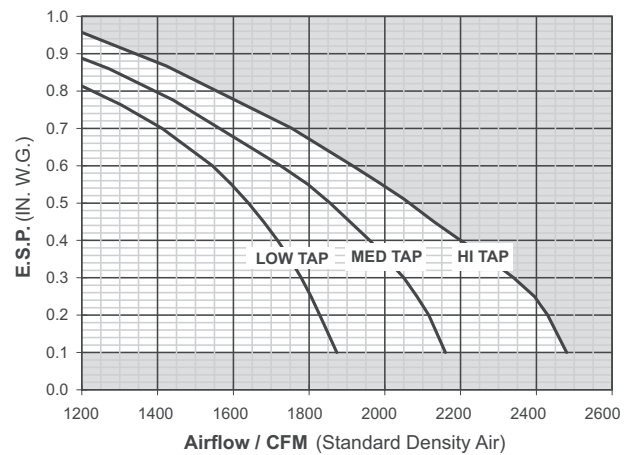

UNIT SIZE 1621

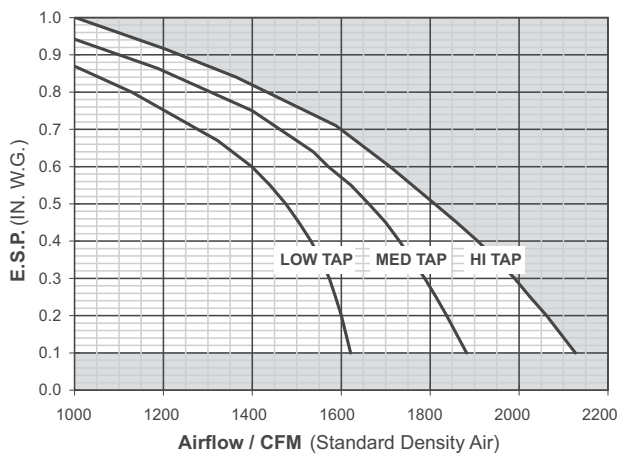

UNIT SIZE 1624

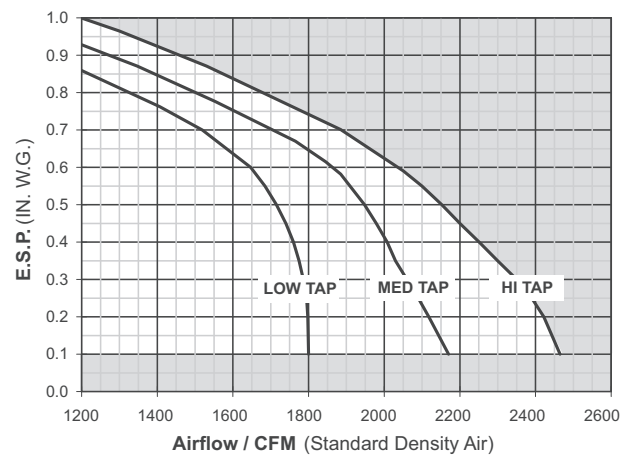

EC FAN MOTOR OPTION

THE ENERGY EFFICIENT SOLUTION

ENVIRO-TEC offers an alternative to the PSC motor that significantly increases the operating efficiency of fan terminal units. This motor is frequently referred to as an ECM (electronically commutated motor). It is a brushless DC (BLDC) motor utilizing a permanent magnet rotor. The motor has been in production for years and is commonly used in residential HVAC units. Fan speed control is accomplished through a microprocessor based variable speed controller (inverter) integral to the motor. The motor provides **peak efficiency ratings between 70 & 80%** for most applications.

ECM FEATURES AND BENEFITS

Ultra-High Motor & Controller Energy Efficiency

DC motors are significantly more efficient than AC motors. At full load the EC motor is typically 20% more efficient than a standard induction motor. Due to acoustical considerations, the fan motor on a fan powered terminal typically operates considerably less than full load. At this condition the overall motor / controller (SCR) efficiency can be cut in half. Due to the permanent magnet, DC design, the EC motor maintains a high efficiency at low speeds. Most fan powered unit selections will have an overall efficiency greater than 75%. Furthermore, the motor heat gain is greatly reduced providing additional energy savings by reducing the cold primary air requirement.

Pressure Independent Fan Volume

The integral microprocessor based controller includes a feature that provides sensorless (no external feedback) constant airflow operation by automatically adjusting the speed and torque in response to system pressure changes. This breakthrough will no doubt have far reaching benefits and endless applications. For starters, the fan volume supplied to the space will not significantly change as a filter becomes loaded. This provides new opportunities for medical applications where space pressurization and HEPA filters are applied. The air balance process will become simpler and more accurate since the fan volume will not need to be re-adjusted after the diffuser balance is accomplished.

Factory Calibrated Fan Volume

Due to the pressure independent feature, the fan capacity can now be calibrated at the factory. Within the published external pressure limits, the fan motor will automatically adjust to account for the varying static pressure requirements associated with different downstream duct configurations. This feature should not preclude the final field air balance verification process during the commissioning stage of a project. An electronic (PWM) speed control device is provided to

allow field changes of the fan capacity as the need arises. Fan volume can be field calibrated in two fashions depending on the type of PWM control board provided on the unit. For the Solo PWM board, a potentiometer is provided allowing manual adjustment using an instrument type screwdriver. If a Sync PWM board is provided, the fan volume can be calibrated through the BMS using an analog output (2 to 10VDC typical) to the speed controller. A fan volume versus DC volts calibration chart is provided.

Designer / Owner Flexibility

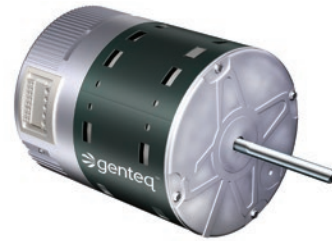

The ECM incorporates ball bearings in lieu of sleeve bearings typically utilized with an induction motor. Unlike a sleeve bearing motor, the ECM does not have a minimum RPM requirement for

bearing lubrication. This allows it to operate over a much wider speed range. One motor can handle the capacity range previously handled by two motors, allowing simplification of the product line and considerable flexibility to the designer. The owner also benefits since equipment changes are much less likely with tenant requirement changes. A reduced spare parts inventory is another plus.

Custom Applications — Programmable Fan Operation

Boundless control opportunities arise due to the controllability of a DC motor combined with an integral microprocessor. Various input signals can direct the motor to behave in an application specific mode. For instance, multiple discrete fan capacities can be achieved. In addition, the fan speed can be varied in response to the space temperature load. The fan can also be programmed for a soft start. The motor starts at a very low speed and slowly ramps up to the required speed. This is especially beneficial for parallel flow fan terminals since the perceived change in space sound levels is lessened.

Extended Motor Life

The high motor efficiency provides a significantly reduced operating temperature compared to an induction motor. The lower temperature increases the longevity of all electrical components and therefore the life of the motor. The ball bearings do not require lubrication and do not adversely impact the motor life. Most fan powered applications will provide a motor life between 60,000 and 100,000 hours. A motor life of twenty five years will not be uncommon for a series flow fan terminal and a longer life can be expected for a parallel flow unit.

GENERAL SELECTION, 60 Hz EC MOTOR

Most variable speed electronic devices, including the EC motor, operate with a rectified and filtered AC power. As a result of the power conditioning, the input current draw is not sinusoidal; rather, the current is drawn in pulses at the peaks of the AC voltage. This pulsating current includes high frequency components called harmonics.

Careful design must be provided when connecting single-phase products to three-phase systems to avoid potential problems such as overheating of neutral wiring conductors, connectors, and transformers. In addition, design consideration must be provided to address the degradation of power quality by the creation of wave shape distortion.

Harmonic currents circulate on the delta side of a Delta-Wye distribution transformer. On the Wye side of the transformer, these harmonic currents are additive on the neutral conductor. A transformer used in this type of application must be sized to carry the output KVA that will include the KVA due to circulating currents.

In summary, proper consideration must be given to the power distribution transformer selection and ground neutral conductor design to accommodate the 3-phase neutral AMPs shown in the adjacent table. Specific guidelines are available from the factory.

PRIMARY AIR VALVE												
Unit Size	CFM	Fan Size	Min delta P's (IN.W.G.)	ROOM NOISE CRITERIA (NC)						Fan HP	Volts	FLA
				0.5" w.g. Δ P		1.0" w.g. Δ P		3.0" w.g. Δ P				
				Dis.	Rad.	Dis.	Rad.	Dis.	Rad.			
0606	200	06	0.03	--	--	--	--	--	22	1/3	120	5
	250		0.04	--	--	--	--	--	24		208	3
	300		0.06	--	--	--	--	--	25		240	2.8
	350		0.08	--	--	--	20	--	28		277	2.6
	450		0.14	--	22	--	25	24	32			
0806	500		0.04	-	-	-	22	23	33			
	600		0.01	-	-	-	24	24	32			
0811 1011 1211	300	11	0.01	--	--	--	--	--	29	1/2	120	7.7
	400		0.03	--	--	--	20	--	32		208	5
	500		0.04	--	--	--	23	22	33		240	4.3
	600		0.06	--	22	--	25	25	35		277	4.1
	700		0.07	--	24	20	27	27	37			
	800		0.1	--	27	20	30	29	38			
	1000		0.15	20	32	24	35	32	40			
	1100		0.02	-	24	-	28	28	37			
1018 1218 1418	600	18	0.01	-	-	-	24	24	32	1/2	120	7.7
	800		0.01	-	23	-	27	25	35		208	5
	1000		0.01	-	25	-	29	28	37		240	4.3
	1200		0.02	-	29	20	32	30	40		277	4.1
	1400		0.02	-	33	23	33	33	42			
	1600		0.03	22	34	25	35	34	44			
1221 1421 1621	800	21	0.01	-	20	-	24	24	34	3/4	120 ⁵	9.6
	1100		0.02	-	24	-	28	28	37		208	7.3
	1400		0.04	-	28	22	32	32	40		240	6.8
	1500		0.04	-	22	20	28	32	40		277	5.5
	1700		0.06	-	32	24	34	35	45			
	2000		0.08	-	35	25	38	38	48			
	2300		0.10	22	37	28	40	40	50			
1424 1624	1100	24	0.02	-	-	-	23	25	33	1	120 ⁵	12.8
	1600		0.01	-	24	-	33	29	42		208	9.4
	2100		0.02	-	28	23	37	33	47		240	9.1
	2600		0.03	22	30	28	39	36	49		277	6.9
	3100		0.04	24	35	33	42	40	50			
	3600		0.05	25	37	37	43	44	54			
	4100		0.07	27	38	38	45	50	57			

NOTES:

1. Min. ΔPs is the static pressure difference across the primary air valve with the damper wide open. All downstream losses (including optional hot water coil) are handled by the unit fan and need not be considered for primary air performance calculations. Data is certified in accordance with the AHRI 880 certification program.
 2. NC values calculated based upon the 2002 Addendum to AHRI Standard 885 Appendix E **Typical Sound Attenuation Values** (shown at right).
 3. Calculate wire feeder size and maximum overcurrent protective device per NEC and local code requirements. Recommended fuse type shall be UL Class RK5, J, CC or other motor rated fuse.
 4. For three-phase conductor sizing, multiply FLA by 1.73.
- * Includes factory provided 2mH choke for power factor correction.

DISCHARGE ATTENUATION VALUES	OCTAVE BAND						
	2	3	4	5	6	7	
Small Box (< 300 CFM)	24	28	39	53	59	40	
Medium Box (300-700 CFM)	27	29	40	51	53	39	
Large Box (> 700 CFM)	29	30	41	51	52	39	

RADIATED ATTENUATION VALUES	OCTAVE BAND						
	2	3	4	5	6	7	
Type 2 - Mineral Fiber Ceiling	18	19	20	26	31	36	

FAN PERFORMANCE, 60 Hz EC MOTOR

GENERAL FAN NOTE

The fan curves depicted on this page are for EC motors. Actual specified capacities which fall below the fan curve can be obtained by adjustment of the fan speed controller. Selections should only be made in the non-shaded areas. The minimum external static pressure requirement is shown for each fan assembly. The unit fan should not be energized prior to realizing this minimum external static pressure.

Terminals equipped with a hot water heating coil require the addition of the coil pressure drop to the specified external static pressure before making the fan selection.

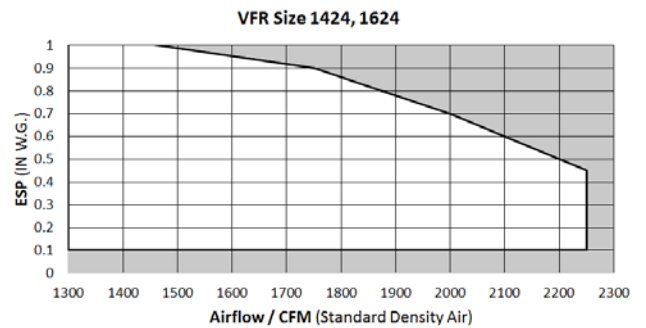
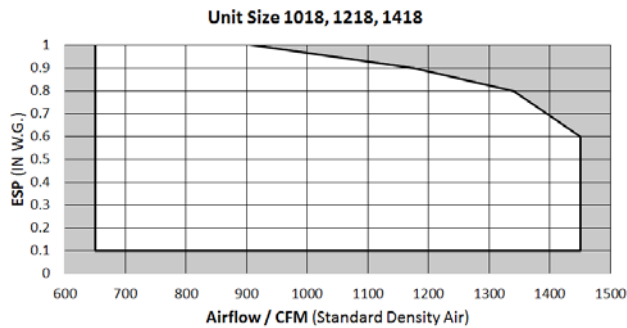
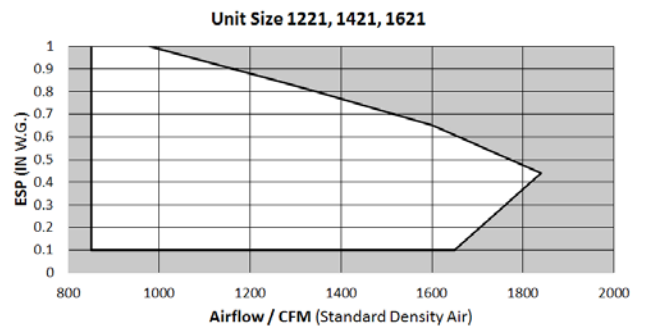
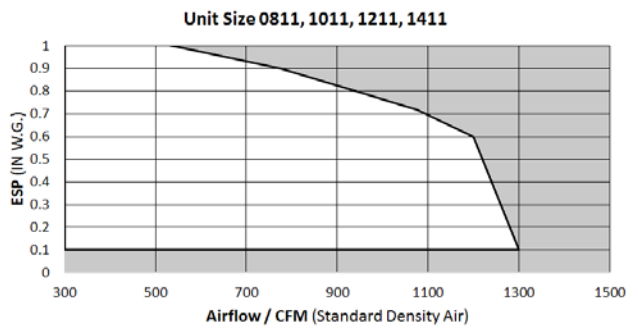
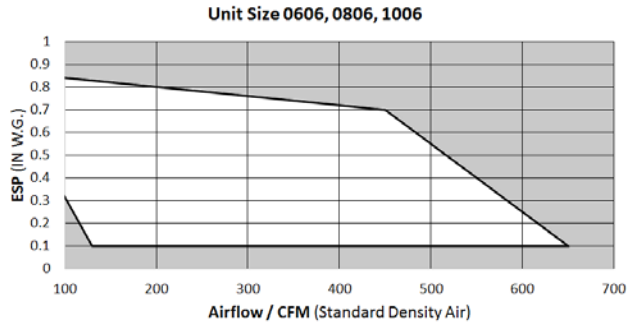

AHRI RATINGS

FAN PERFORMANCE

UNIT SIZE	FAN CFM	POWER (WATTS)	SOUND POWER LEVEL, dB re: 10 ⁻¹² WATTS											
			DISCHARGE						RADIATED					
			Hz Octave Band Center Frequency						Hz Octave Band Center Frequency					
			125	250	500	1000	2000	4000	125	250	500	1000	2000	4000
0604	380	120	64	58	51	47	40	37	67	67	57	52	46	45
0606	510	200	70	64	58	54	50	50	72	67	60	58	55	55
0804	410	130	63	57	51	54	47	44	67	67	57	52	46	45
0806	520	220	71	65	60	57	53	53	73	67	61	58	56	55
0811	970	380	73	66	64	63	57	56	70	66	63	62	57	57
1006	540	220	69	64	59	56	53	53	73	67	61	58	56	55
1011	1100	420	73	65	64	65	59	57	76	68	63	62	59	59
1018	1800	810	77	71	67	68	63	64	75	70	67	65	62	62
1211	1125	440	73	67	65	65	61	60	76	68	63	62	59	59
1218	1850	840	76	71	67	68	63	64	76	70	67	66	63	63
1221	1950	840	77	70	67	67	63	64	75	70	67	65	63	62
1411	1075	450	71	64	65	65	59	57	76	68	63	62	59	59
1418	1900	880	76	70	67	68	63	64	76	70	67	66	63	63
1421	2050	920	77	69	69	69	63	64	76	71	68	67	65	64
1424	2400	1000	77	70	70	70	66	66	76	72	68	67	65	63
1621	2050	950	78	71	69	69	65	64	76	71	68	67	65	64
1624	2400	1000	76	70	70	70	66	66	76	72	68	67	65	63

NOTE: Fan external static pressure is 0.25" w.g.

- Duct end corrections included in sound power levels per AHRI Standard 880.

PRIMARY AIR VALVE PERFORMANCE

UNIT SIZE	PRIMARY CFM	MINIMUM OPERATING PRESSURE (In. Water)	SOUND POWER LEVEL, dB re: 10 ⁻¹² WATTS											
			DISCHARGE						RADIATED					
			Hz Octave Band Center Frequency						Hz Octave Band Center Frequency					
			125	250	500	1000	2000	4000	125	250	500	1000	2000	4000
0604	400	0.12	71	65	56	48	42	42	62	54	50	42	36	31
0606	400	0.12	71	65	56	48	42	42	62	54	50	42	36	31
0804	700	0.13	75	68	62	55	50	48	66	58	52	45	40	33
0806	700	0.13	75	68	62	55	50	48	66	58	52	45	40	33
0811	700	0.13	75	68	62	55	50	48	66	58	52	45	40	33
1006	1100	0.02	74	68	61	55	50	48	68	60	54	46	40	38
1011	1100	0.02	74	68	61	55	50	48	68	60	54	46	40	38
1018	1100	0.02	74	68	61	55	50	48	68	60	54	46	40	38
1211	1600	0.06	75	71	65	61	60	55	71	63	60	53	47	37
1218	1600	0.06	75	71	65	61	60	55	71	63	60	53	47	37
1221	1600	0.06	75	71	65	61	60	55	71	63	60	53	47	37
1411	2100	0.08	81	71	65	58	54	51	73	61	54	46	40	38
1418	2100	0.08	81	71	65	58	54	51	73	61	54	46	40	38
1421	2100	0.08	81	71	65	58	54	51	73	61	54	46	40	38
1424	2100	0.08	81	71	65	58	54	51	73	61	54	46	40	38
1621	2800	0.04	83	74	72	70	63	59	77	68	61	52	44	40
1624	2800	0.04	83	74	72	70	63	59	77	68	61	52	44	40

NOTE: Inlet static pressure is 1.5" w.g.

- Duct end corrections included in sound power levels per AHRI Standard 880.



ELECTRIC HEAT

MODEL VFR-EH

STANDARD FEATURES

- cETL listed as an assembly for safety compliance per UL 1995
- Primary auto-reset high limit
- Secondary high limit
- Hinged control panel
- Ni-Chrome elements
- Primary/secondary power terminations
- Fusing per NEC
- Wiring diagram and ETL label
- Fan interlock device (relay or P.E. switch)
- Single point power connection
- Available kW increments are as follows:
0.5 to 10.0 kW - .50 kW; 10.0 to 25.0 kW - 1.0 kW;
above 25.0 - 2.0 kW

OPTIONAL FEATURES

- Disconnect (toggle or door interlocking)
- P.E. switches
- Magnetic contactors
- Manual reset secondary limit
- Proportional control (SSR)
- 24 volt control transformer
- Special watt densities
- Airflow switch
- ECM motor control

SELECTION PROCEDURE

With standard heater elements, the maximum capacity (kW) is obtained by dividing the heating (fan) SCFM by 70. In other words, the terminal must have at least 70 SCFM per kW. Optional heater elements are available to handle applications requiring less CFM per kW. In addition, each size terminal has a maximum allowable kW based upon the specific heater element configuration (i.e. voltage, phase, number of steps, etc.). Contact your representative or refer to the web-based Computer Selection Program "Web-Select" for design assistance.

Heaters require a minimum of 0.07" w.g. downstream static pressure to ensure proper operation.

For optimum diffuser performance in overhead heating applications, the supply air temperature should be within 20°F of the desired space temperature. This typically requires a higher air capacity which provides higher air motion in the space increasing thermal comfort. The electric heater should be selected with this in mind, keeping the LAT as low as possible.

Selection Equations

$$kW = \frac{SCFM \times \Delta T \times 1.085^*}{3413}$$

$$CFM = \frac{kW \times 3413}{\Delta T \times 1.085^*}$$

$$\Delta T = \frac{kW \times 3413}{SCFM \times 1.085^*}$$

* Air density at sea level - reduce by 0.036 for each 1000 feet of altitude above sea level.

PRESSURE DROP ΔPs (INCHES W.G.)

UNIT SIZE	CFM	ΔPs	UNIT SIZE	CFM	ΔPs
0404	100	.01	1006 1011 1018	600	.02
	150	.01		800	.03
	200	.02		1000	.04
	250	.03		1200	.06
0504	100	.01		1400	.08
	200	.02		1600	.11
	300	.05		800	.02
	350	.07		1100	.03
0604 0606	200	.02	1211 1218 1221	1400	.05
	250	.03	1700	.07	
	300	.05	2000	.11	
	350	.07	2300	.14	
	450	.11	1100	.01	
	550	.17	1500	.02	
0804 0806 0811	300	.02	1411 1418 1421 1424	1900	.03
	400	.04	2300	.04	
	500	.06	2700	.05	
	600	.09	3100	.07	
	800	.16	1600	.01	
	1000	.25	2100	.02	
		1621 1624	2600	.03	
			3100	.05	
			3600	.06	
			4100	.08	

MAXIMUM ALLOWABLE kW

UNIT SIZE	MAX. kW	UNIT SIZE	MAX. kW
0404, 0504, 0604	5.5	1411	15
		1018, 1218	26
0804	6	1418	27
0606	8	1221	28
0806, 1006	8.5	1421, 1621	29
0811	14	1424, 1624	34
1011, 1211	16		

Calculating Line Amperage

$$\text{Single Phase Amps} = \frac{kW \times 1000}{\text{Volts}}$$

$$\text{Three Phase Amps} = \frac{kW \times 1000}{\text{Volts} \times 1.73}$$

HOT WATER COIL DATA

MODEL VFR-WC



STANDARD FEATURES

- Coils are designed, manufactured and tested by ENVIRO-TEC
- Aluminum fin construction with die-formed spacer collars for uniform spacing
- Mechanically expanded copper tubes, leak tested to 450 PSIG air pressure and rated at 300 PSIG working pressure at 200°F
- 1, 2, 3 and 4 row configurations
- Male sweat type water connections

OPTIONAL FEATURES

- Steam coils
- Multi-circuit coils for reduced water pressure drop
- Opposite hand water connections
- ECM motor control

DEFINITION OF TERMS

- EAT** Entering Air Temperature (°F)
- LAT** Leaving Air Temperature (°F)
- EWT** Entering Water Temperature (°F)
- LWT** Leaving Water Temperature (°F)
- CFM** Air Capacity (Cubic Feet per Minute)
- GPM** Water Capacity (Gallons per Minute)
- MBH** 1,000 BTUH
- BTUH** Coil Heating Capacity (British Thermal Units per Hour)
- $\Delta TEWT$ minus EAT

SELECTION PROCEDURE

Hot Water Coil Performance Tables are based upon a temperature difference of 115°F between entering water and entering air. If this ΔT is suitable, proceed directly to the performance tables for selection. All pertinent performance data is tabulated.

ENTERING WATER - AIR TEMPERATURE DIFFERENTIAL (ΔT) CORRECTION FACTORS															
ΔT	10	15	20	25	30	35	40	45	50	55	60	65	70	75	80
FACTOR	0.15	0.19	0.23	0.27	0.31	0.35	0.39	0.43	0.47	0.51	0.55	0.59	0.63	0.67	0.71
ΔT	85	90	95	100	105	110	115	120	125	130	135	140	145	150	155
FACTOR	0.75	0.79	0.83	0.88	0.92	0.96	1	1.04	1.08	1.13	1.17	1.21	1.25	1.29	1.33

The table above gives correction factors for various entering ΔT 's (difference between entering water and entering air temperatures). Multiply MBH values obtained from selection tables by the appropriate correction factor above to obtain the actual MBH value. Air and water pressure drop can be read directly from the selection table. The leaving air and leaving water temperatures can be calculated from the following fundamental formulas:

$$LAT = \frac{EAT + BTUH}{1.085 \times CFM}$$

$$LWT = EWT - \frac{BTUH}{500 \times GPM}$$

A web-based Computer Selection Program, "Web-Select", is available to facilitate the selection process. Contact your representative to obtain access to this powerful and time-saving program.

HOT WATER COIL DATA**MODEL VFR-WC UNIT SIZES 0404, 0504, 0604, 0804, 0806, 0811**

AIRFLOW		WATER FLOW			LAT (°F)		LWT (°F)		CAPACITY (MBH)	
Rate (CFM)	Air PD (IN. W.G.)	Rate (GPM)	Water PD (FT. W.G.)		1 Row	2 Row	1 Row	2 Row	1 Row	2 Row
			1 Row	2 Row						
200	1 Row 0.01 2 Row 0.01	0.5	0.3	0.1	114.5	129.2	136.1	123.2	10.7	13.9
		1	1.2	--	122.6	--	154.4	--	12.5	--
		2	4.1	--	127.7	--	166.0	--	13.6	--
		3	8.6	--	129.6	--	170.4	--	14.0	--
		5	--	--	--	--	--	--	--	--
300	1 Row 0.01 2 Row 0.02	0.5	0.3	0.1	104.4	116.0	127.8	112.5	12.8	16.6
		1	1.2	0.3	112.7	130.7	148.2	136.3	15.5	21.4
		2	5.9	--	129.2	--	158.6	--	20.9	--
		3	8.7	--	120.3	--	167.7	--	18.0	--
		5	22.0	--	122.2	--	172.4	--	18.6	--
400	1 Row 0.02 2 Row 0.03	0.5	0.3	0.1	97.9	107.2	122.1	105.7	14.3	18.3
		1	1.2	0.3	106.1	121.8	143.6	129.7	17.8	24.7
		2	4.2	--	111.7	--	159.2	--	20.3	--
		3	8.7	--	113.9	--	165.5	--	21.2	--
		5	22.0	--	115.9	--	170.9	--	22.1	--
500	1 Row 0.02 2 Row 0.05	0.5	0.3	--	93.2	--	117.9	--	15.3	--
		1	1.2	0.3	101.2	115.2	139.9	124.6	19.6	27.2
		2	4.2	1.2	106.9	126.5	156.7	145.9	22.7	33.3
		3	8.7	--	109.2	--	163.6	--	24.0	--
		5	22.1	--	111.2	--	169.7	--	25.1	--
600	1 Row 0.03 2 Row 0.07	0.5	0.4	--	89.8	--	114.8	--	16.1	--
		1	1.2	0.3	97.5	109.9	136.9	120.6	21.2	29.2
		2	4.2	1.2	103.2	121.3	154.6	142.5	24.8	36.6
		3	8.7	2.5	105.5	126.3	162.0	152.8	26.3	39.9
		5	22.1	--	107.6	--	168.6	--	27.7	--
700	1 Row 0.04 2 Row 0.09	0.5	0.4	--	87.0	--	112.5	--	16.7	--
		1	1.2	0.3	94.6	105.7	134.3	117.3	22.4	30.9
		2	4.2	1.2	100.2	117.0	152.7	139.7	26.7	39.5
		3	8.7	2.5	102.5	122.1	160.6	150.4	28.5	43.3
		5	22.1	6.2	104.6	126.9	167.7	160.7	30.1	47.0
800	1 Row 0.06 2 Row 0.11	0.5	0.4	--	84.8	--	110.7	--	17.2	--
		1	1.2	0.3	92.1	102.1	132.2	114.7	23.5	32.2
		2	4.2	1.2	97.7	113.3	151.0	137.2	28.3	41.9
		3	8.8	2.5	100.0	118.5	159.3	148.3	30.3	46.4
		5	22.1	6.2	102.1	123.4	166.8	159.2	32.2	50.6

NOTES:

1. Data is based on 180°F entering water and 65°F entering air temperature at sea level. See computer selection program for other conditions.
2. For optimum diffuser performance in overhead heating applications, the supply air temperature should be within 20°F of the desired space temperature. This typically requires a higher air capacity which provides higher air motion in the space, increasing thermal comfort. The hot water coil should be selected with this in mind, keeping the LAT as low as possible.

A web-based Computer Selection Program, "Web-Select", is available to facilitate the selection process. Contact your representative to obtain access to this powerful and time-saving program.

HOT WATER COIL DATA

MODEL VFR-WC UNIT SIZES 1006, 1018, 1211, 1218, 1221

AIRFLOW		WATER FLOW			LAT (°F)		LWT (°F)		CAPACITY (MBH)	
Rate (CFM)	Air PD (IN. W.G.)	Rate (GPM)	Water PD (FT. W.G.)		1 Row	2 Row	1 Row	2 Row	1 Row	2 Row
			1 Row	2 Row						
400	1 Row 0.01 2 Row 0.02	0.5	0.4	0.1	102.6	111.7	113.7	97.9	16.3	20.2
		1	1.5	0.4	112.5	128.3	137.8	124.0	20.6	27.4
		2	5.2	--	119.3	--	155.8	--	23.6	--
		3	10.9	--	122.0	--	163.1	--	24.7	--
		5	27.6	--	124.4	--	169.4	--	25.7	--
600	1 Row 0.02 2 Row 0.03	0.5	0.5	--	93.5	--	105.0	--	18.6	--
		1	1.5	0.4	103.0	115.6	129.6	113.1	24.7	32.9
		2	5.3	1.5	109.9	128.8	150.1	137.6	29.3	41.5
		3	11.0	--	112.8	--	158.7	--	31.1	--
		5	27.7	--	115.3	--	166.5	--	32.8	--
800	1 Row 0.03 2 Row 0.05	0.5	0.5	--	87.9	--	99.9	--	19.9	--
		1	1.6	0.4	96.9	107.1	123.8	106.0	27.6	36.5
		2	5.3	1.5	103.8	120.3	145.6	131.0	33.6	48.0
		3	11.0	3.1	106.7	126.4	155.3	143.7	36.1	53.2
		5	27.8	--	109.3	--	164.2	--	38.4	--
1000	1 Row 0.04 2 Row 0.08	0.5	0.5	--	84.1	--	96.9	--	20.7	--
		1	1.6	0.5	92.5	101.0	119.5	101.1	29.8	39.1
		2	5.4	1.5	99.3	113.9	142.1	125.9	37.2	53.1
		3	11.1	3.2	102.2	120.1	152.5	139.3	40.3	59.7
		5	27.9	7.9	104.8	126.1	162.3	152.8	43.2	66.2
1200	1 Row 0.05 2 Row 0.11	0.5	--	--	--	--	--	--	--	--
		1	1.6	0.5	89.3	96.4	116.2	97.6	31.6	40.9
		2	5.4	1.5	95.8	108.9	139.1	121.9	40.1	57.2
		3	11.1	3.2	98.7	115.1	150.1	135.6	43.9	65.2
		5	27.9	7.9	101.4	121.2	160.6	150.1	47.4	73.1
1400	1 Row 0.07 2 Row 0.14	0.5	--	--	--	--	--	--	--	--
		1	1.6	0.5	86.7	92.8	113.6	95.1	32.9	42.2
		2	5.4	1.6	93.1	104.9	136.6	118.5	42.6	60.5
		3	11.2	3.2	95.9	111.0	148.0	132.6	47.0	69.8
		5	28.0	8.0	98.6	117.1	159.1	147.6	51.0	78.1
1600	1 Row 0.09 2 Row 0.18	0.5	--	--	--	--	--	--	--	--
		1	1.6	0.5	84.6	89.9	111.6	93.4	34.0	43.2
		2	5.5	1.6	90.8	101.5	134.5	115.8	44.8	63.4
		3	11.3	3.2	93.6	107.5	146.2	129.9	49.7	73.8
		5	28.1	8.0	96.3	113.7	157.8	145.4	54.3	84.5
1800	1 Row 0.11 2 Row 0.23	0.5	--	--	--	--	--	--	--	--
		1	1.7	0.5	82.9	87.5	109.9	92.2	34.9	43.9
		2	5.5	1.6	88.9	98.7	132.6	113.4	46.7	65.8
		3	11.3	3.2	91.7	104.6	144.6	127.6	52.1	77.3
		5	28.2	8.0	94.4	110.7	156.6	143.5	57.3	89.3

See Notes on previous page.

A web-based Computer Selection Program, "Web-Select", is available to facilitate the selection process. Contact your representative to obtain access to this powerful and time-saving program.

HOT WATER COIL DATA**MODEL VFR-WC UNIT SIZES 1411, 1418, 1421, 1424, 1621, 1624**

AIRFLOW		WATER FLOW			LAT (°F)		LWT (°F)		CAPACITY (MBH)	
Rate (CFM)	Air PD (IN. W.G.)	Rate (GPM)	Water PD (FT. W.G.)		1 Row	2 Row	1 Row	2 Row	1 Row	2 Row
			1 Row	2 Row						
1000	1 Row 0.03 2 Row 0.06	0.5	0.6	--	85.0	--	93.0	--	21.7	--
		1	1.8	0.5	94.0	102.4	116.3	98.0	31.5	40.6
		2	6.0	1.7	101.3	116.1	139.8	123.5	39.4	55.5
		3	12.4	3.6	104.5	122.7	150.8	137.4	42.8	62.6
		5	31.2	8.9	107.4	129.0	161.1	151.5	46.0	69.5
1200	1 Row 0.04 2 Row 0.08	0.5	--	--	--	--	--	--	--	--
		1	1.8	0.5	90.6	97.7	112.7	94.3	33.3	42.5
		2	6.1	1.7	97.7	111.0	136.6	119.2	42.6	59.8
		3	12.5	3.6	100.9	117.6	148.2	133.5	46.7	68.4
		5	31.3	8.9	103.8	124.1	159.3	148.5	50.5	76.9
1400	1 Row 0.05 2 Row 0.11	0.5	--	--	--	--	--	--	--	--
		1	1.8	0.5	87.9	94.0	109.9	91.6	34.7	44.0
		2	6.1	1.8	94.8	106.8	133.9	115.6	45.3	63.4
		3	12.6	3.6	97.9	113.3	146.0	130.1	50.0	73.4
		5	31.4	8.9	100.9	119.9	157.7	145.9	54.5	83.4
1600	1 Row 0.07 2 Row 0.14	0.5	--	--	--	--	--	--	--	--
		1	1.6	0.5	84.6	90.9	111.6	89.7	34.0	45.0
		2	6.2	1.8	92.5	103.3	131.6	112.6	47.6	66.5
		3	12.6	3.6	95.5	109.8	144.0	127.3	53.0	77.7
		5	31.5	9.0	98.5	116.4	156.2	143.5	58.1	89.2
1800	1 Row 0.09 2 Row 0.17	0.5	--	--	--	--	--	--	--	--
		1	1.9	0.6	83.9	88.4	106.0	88.4	36.9	45.8
		2	6.2	1.8	90.5	100.4	129.6	110.1	49.7	69.0
		3	12.7	3.6	93.5	106.7	142.2	124.8	55.6	81.5
		5	31.6	9.0	96.4	113.3	154.9	141.4	61.3	94.3
2000	1 Row 0.10 2 Row 0.21	0.5	--	--	--	--	--	--	--	--
		1	1.9	--	82.3	--	104.6	--	37.6	--
		2	6.3	1.8	88.8	97.9	127.8	108.0	51.5	71.3
		3	12.8	3.7	91.8	104.1	140.6	122.6	58.0	84.8
		5	31.7	9.0	94.6	110.7	153.7	139.6	64.3	99.0
2200	1 Row 0.12 2 Row 0.25	0.5	--	--	--	--	--	--	--	--
		1	2.0	--	81.0	--	103.5	--	38.2	--
		2	6.3	1.8	87.3	95.7	126.2	106.2	53.2	73.2
		3	12.8	3.7	90.2	101.8	139.2	120.6	60.2	87.8
		5	31.8	9.1	93.1	108.3	152.6	137.8	67.0	103.3

NOTES:

1. Data is based on 180°F entering water and 65°F entering air temperature at sea level. See computer selection program for other conditions.
2. For optimum diffuser performance in overhead heating applications, the supply air temperature should be within 20°F of the desired space temperature. This typically requires a higher air capacity which provides higher air motion in the space, increasing thermal comfort. The hot water coil should be selected with this in mind, keeping the LAT as low as possible.

A web-based Computer Selection Program, "Web-Select", is available to facilitate the selection process. Contact your representative to obtain access to this powerful and time-saving program.

GUIDE SPECIFICATIONS

GENERAL

Furnish and install ENVIRO-TEC Model VFR parallel flow variable volume fan powered terminals of the sizes and capacities scheduled. Units shall be ETL listed. Terminals with electric heat shall be listed as an assembly. Separate listings for the terminal and electric heater are not acceptable. Terminals shall include a single point electrical connection. Terminal units shall be AHRI certified and bear the AHRI 880 seal.

The entire unit shall be designed and built as a single unit. Field-assembled components or built-up terminals employing components from multiple manufacturers are not acceptable.

CONSTRUCTION

Terminals shall be constructed of not less than 20 gauge galvanized steel, able to withstand a 125 hour salt spray test per ASTM B-117. Stainless steel casings, or galvanized steel casings with a baked enamel paint finish, may be used as an alternative. The terminal casing shall be mechanically assembled (spot-welded casings are not acceptable).

Casing shall be internally lined with 3/4" thick fiberglass insulation, rated for a maximum air velocity of 5000 f.p.m. Maximum thermal conductivity shall be .24 (BTU • in) / (hr • ft² • °F). Insulation must meet all requirements of ASTM C1071 (including C665), UL 181 for erosion, and carry a 25/50 rating for flame spread/smoke developed per ASTM E-84, UL 723 and NFPA 90A. Raw insulation edges on the discharge of the unit must be covered with metal liner to eliminate flaking of insulation during field duct connections. Simple "buttering" of raw edges with an approved sealant is not acceptable.

Casing shall have bottom or side access to gain access to the fan assembly. The opening shall be sufficiently large to allow complete removal of the fan if necessary. The casing shall be constructed in a manner to provide a single rectangular discharge collar. Multiple discharge openings are not acceptable. All appurtenances including control assemblies, control enclosures, hot water heating coils, and electric heating coils shall not extend beyond the top or bottom of the unit casing.

SOUND

The terminal manufacturer shall provide AHRI certified sound power data for radiated and discharge sound. The sound levels shall not exceed the octave band sound power levels indicated on the schedule. If the sound data does not meet scheduled criteria, the contractor shall be responsible for the provision and installation of any additional equipment or material necessary to achieve the scheduled sound performance.

PRIMARY AIR VALVE

The primary air valve shall consist of a minimum 22 gauge cylindrical body that includes embossment rings for rigidity. The damper blade shall be connected to a solid shaft by means of an integral molded sleeve which does not require screw or bolt fasteners. The shaft shall be manufactured of a low thermal conducting composite material, and include a molded damper position indicator visible from the exterior of the unit. The damper shall pivot in self lubricating bearings. The damper actuator shall be mounted on the exterior of the

terminal for ease of service. The valve assembly shall include internal mechanical stops for both full open and closed positions. The damper blade seal shall be secured without use of adhesives. The air valve leakage shall not exceed 1% of maximum inlet rated airflow at 3" W.G. inlet pressure.

PRIMARY AIRFLOW SENSOR

For inlet diameters 6" or greater, the differential pressure airflow sensor shall traverse the duct along two perpendicular diameters. Cylindrically shaped inlets shall utilize the equal cross sectional area or log-linear traverse method. Single axis sensor shall not be acceptable for duct diameters 6" or larger. A minimum of 12 total pressure sensing points shall be utilized. The total pressure inputs shall be averaged using a pressure chamber located at the center of the sensor. A sensor that delivers the differential pressure signal from one end of the sensor is not acceptable. The sensor shall output an amplified differential pressure signal that is at least 2.3 times the equivalent velocity pressure signal obtained from a conventional pitot tube. The sensor shall develop a differential pressure of 0.015" w.g. at an air velocity of ≤ 325 FPM. Documentation shall be submitted which substantiates this requirement. Balancing taps and airflow calibration charts shall be provided for field airflow measurements.

FAN ASSEMBLY

The unit fan shall utilize a forward curved, dynamically balanced, galvanized wheel with a direct drive motor. The motor shall be permanent split capacitor type with three separate horsepower taps. Single speed motors with electronic speed controllers are not acceptable.

The fan motor shall be unpluggable from the electrical leads at the motor case for simplified removal (open frame motors only). The motor shall utilize permanently lubricated sleeve type bearings, include thermal overload protection and be suitable for use with electronic and/or mechanical fan speed controllers. The motor shall be mounted to the fan housing using torsion isolation mounts properly isolated to minimize vibration transfer.

The terminal shall utilize an electronic (SCR) fan speed controller for aid in balancing the fan capacity. The speed controller shall have a turn down stop to prevent possibility of harming motor bearings.

HOT WATER COIL

Terminal shall include an integral hot water coil where indicated on the plans. The coil shall be manufactured by the terminal unit manufacturer and shall have a minimum 22 gauge galvanized sheet metal casing. Stainless steel casings, or galvanized steel casings with a baked enamel paint finish, may be used as an alternative. Coil to be constructed of pure aluminum fins with full fin collars to assure accurate fin spacing and maximum tube contact. Fins shall be spaced with a minimum of 10 per inch and mechanically fixed to seamless copper tubes for maximum heat transfer.

Each coil shall be hydrostatically tested at a minimum of 450 PSIG under water, and rated for a maximum 300 PSIG working pressure at 200°F.

ELECTRIC HEATERS

Terminal shall include an integral electric heater where indi-

GUIDE SPECIFICATIONS

cated on the plans. The heater cabinet shall be constructed of not less than 20 gauge galvanized steel. Stainless steel cabinets, or galvanized steel casings with a baked enamel paint finish, may be used as an alternative. Heater shall have a hinged access panel for entry to the controls.

A power disconnect shall be furnished to render the heater non-operational. Heater shall be furnished with all controls necessary for safe operation and full compliance with UL 1995 and National Electric Code requirements.

Heater shall have a single point electrical connection. It shall include a primary disc-type automatic reset high temperature limit, secondary high limit(s), Ni-Chrome elements, and fusing per UL and NEC. Heater shall have complete wiring diagram with label indicating power requirement and kW output. Heater shall be interlocked with fan terminal so as to preclude operation of the heater when the fan is not running.

OPTIONS

Foil Faced Insulation

Insulation shall be covered with scrim backed foil facing. All insulation edges shall be covered with foil or metal nosing. In addition to the basic requirements, insulation shall meet ASTM C1136 for insulation facings, and ASTM C1338 for mold, mildew and humidity resistance.

Elastomeric Closed Cell Foam Insulation

Provide Elastomeric Closed Cell Foam Insulation in lieu of standard. Insulation shall conform to UL 181 for erosion and NFPA 90A for fire, smoke and melting, and comply with a 25/50 Flame Spread and Smoke Developed Index per ASTM E-84 or UL 723. Additionally, insulation shall comply with Antimicrobial Performance Rating of 0, no observed growth, per ASTM G-21. Polyethylene insulation is not acceptable.

Double Wall Construction

The terminal casing shall be double wall construction using a 22 gauge galvanized metal liner covering all insulation.

Filters

Terminals shall include a filter rack and 1" thick disposable fiberglass filter, allowing removal without horizontal sliding.

ECM FAN MOTOR

Fan motor shall be ECM, "Electronically Commutated Motor" "Genteq® Eon." Motor shall be brushless DC controlled by an integral controller / inverter that operates the wound stator and senses rotor position to electronically commutate the stator. Motor shall be permanent magnet type with near-zero rotor losses designed for synchronous rotation. The motor shall utilize permanently lubricated ball bearings. Motor shall maintain minimum 70% efficiency over the entire operating range. Motor speed control shall be accomplished through a PWM (pulse width modulation) controller specifically designed for compatibility with the ECM. The speed controller shall have terminals for field verification of fan capacity utilizing a digital volt meter.

A calibration graph shall be supplied indicating Fan CFM verses DC Volts.

PIPING PACKAGES

Provide a standard factory assembled non-insulated valve

and piping package to consist of a 2 way, on/off, motorized electric control valve and two ball isolation valves. Control valves are piped normally closed to the coil. Maximum entering water temperature on the control valve shall be 200°F. The maximum close-off pressure is 40 PSIG (1/2") or 20 PSIG (3/4"). Maximum operating pressure shall be 300 PSIG.

Option: Provide 3-wire floating point modulating control valve (fail-in-place) in lieu of standard 2-position control valve with factory assembled valve piping package.

Option: Provide high pressure close-off actuators for 2-way, on/off control valves. Maximum close-off pressure is 50 PSIG (1/2") or 25 PSIG (3/4").

Option: Provide either a fixed or adjustable flow control device for each piping package.

Option: Provide unions and/or pressure-temperature ports for each piping package.

Piping package shall be completely factory assembled, including interconnecting pipe, and shipped separate from the unit for field installation on the coil, so as to minimize the risk of freight damage.

CONTROLS

Refer to ENVIRO-TEC Series 7000 Analog Electronic Controls Selection Guide for detailed guide specifications.

PNEUMATIC CONTROLS

Units shall be controlled by a pneumatic differential pressure reset volume controller. Controller shall be capable of pressure independent operation down to 0.03 inches W.G. differential pressure and shall be factory set to the specified airflow (CFM). Controller shall not exceed 11.5 scim (Standard Cubic Inches per Minute) air consumption @ 20 PSIG.

Unit primary air valve shall modulate in response to the room mounted thermostat and shall maintain airflow in relation to thermostat pressure regardless of system static pressure changes. An airflow (CFM) curve shall be affixed to the terminal unit expressing differential pressure vs. CFM. Pressure taps shall be provided for field use and ease of balancing.

Terminal unit manufacturer shall supply and manufacture a 5 to 10 PSIG pneumatic actuator capable of a minimum of 45 in. lbs. of torque.

Actual sequence of operation is shown on the contract drawings. Terminal unit manufacturer shall coordinate, where necessary, with the temperature control contractor.

ENVIRO-TEC is a registered trademark and FlowStar™ is a trademark of Johnson Controls, Inc. in the United States of America and other countries. Other trademarks used herein may be trademarks or registered trademarks of other companies.

Catalog: ET130.13-EG6.1 (418) Supersedes ET130.13-EG6.1 (415)
© 2018 Johnson Controls, Inc. P.O. Box 423, Milwaukee, WI 53201 Printed in USA
www.enviro-tec.com

